

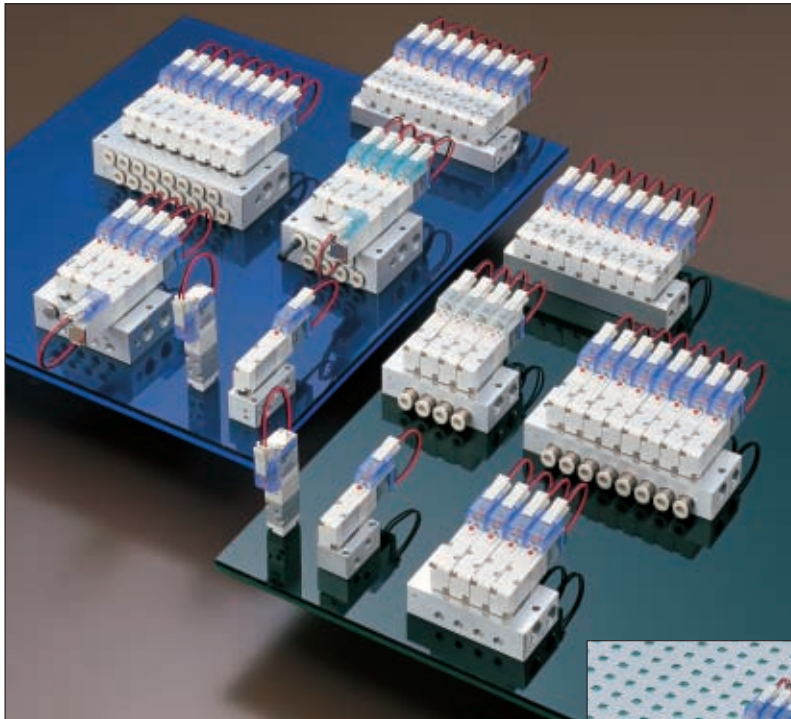

# Solenoid Valves HEA/HEB and HJC/HJE Series



HEA/HEB Series

*Responds to various needs for control!*

**New  
Standard  
Valve**

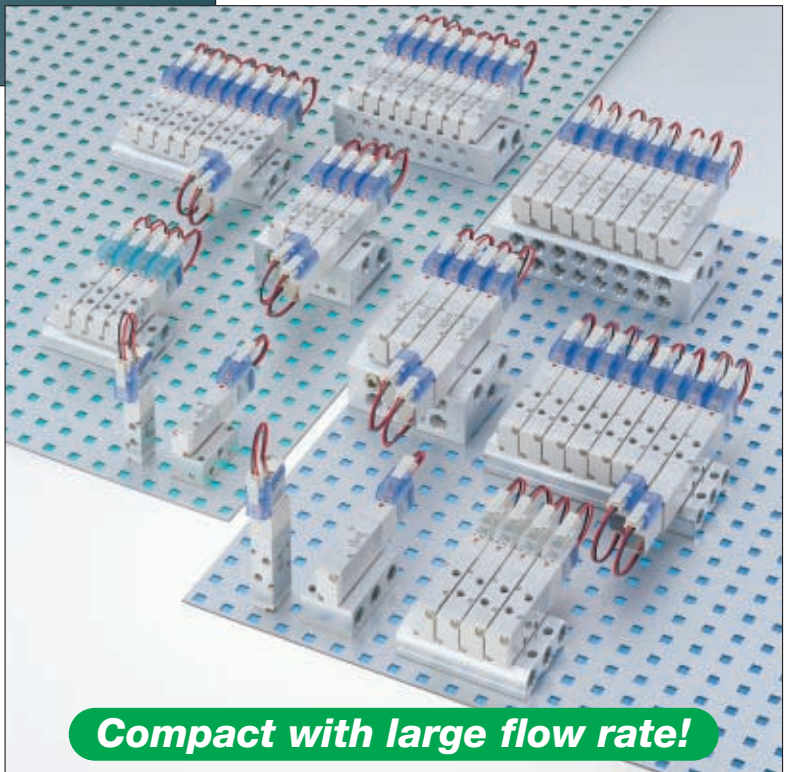

**Compact with large flow rate!**

HJC/HJE Series

**A small, easy-to-use, simple configuration!  
Responsive to varied needs and professional control,  
while achieving still lower power consumption levels and  
quick response!**

# New Standard Valve HEA/HEB Series Solenoid Valves

## HEA series

(2, 3, 5-port pilot type solenoid valves)

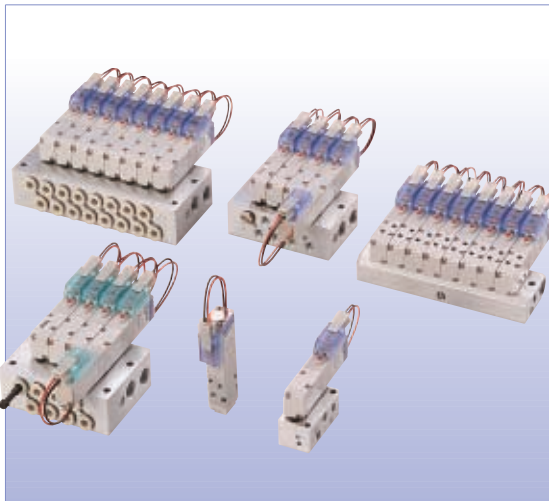

**Provides sure assistance to all factors where solenoid valves are required, on the manufacturing line, or in machinery or equipment.**

**A NEW standard in compact valves!**

● **Space Assist—Thin and compact size**

Valve width: 10mm [0.39in.]  
Valve length: 56.7mm [2.23in.] (HEA series)  
53mm [2.09in.] (HEB series)  
(for standard type)

● **Range Assist—Efficient flow rate**

Sonic conductance C: 0.26dm<sup>3</sup>/(s·bar)  
(Effective area: 1.3mm<sup>2</sup> [Cv: 0.07])  
Optimum for pilot-operated valves, and for operating up to  $\phi$  25 [0.98in.] bore size cylinders.

● **Response Assist—Achieves quick response**

Response time: When ON, max. 6ms  
When OFF, max. 7ms  
(for quick response type single solenoid)

● **Power Assist—Achieves lower power consumption**

Standard type: 0.55W, Low current type: 0.15W

● **Reliability Assist—Improved reliability**

New solenoid configuration and stem configuration congregating valve technology have boosted working life, response, and other basic performance.

● **Environment Assist—Improved environmental tolerance**

Grommet type offers moisture-proof specifications.



## HEB series

(2, 3-port pilot type solenoid valves)

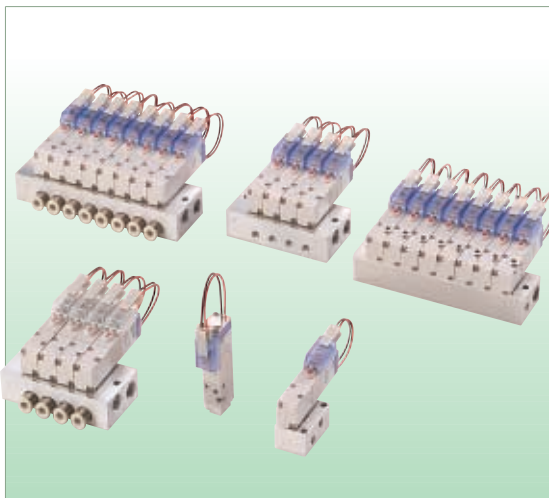



### INDEX

Characteristics and Product Range	1
Safety Precautions	6
General Precautions	8
Handling Instructions and Precautions	9
HEA Series Specifications — 13	HJC Series Specifications — 37
Order Code — 17	Order Code — 41
Dimensions — 20	Dimensions — 44
HEB Series Specifications — 25	HJE Series Specifications — 51
Order Code — 29	Order Code — 55
Dimensions — 32	Dimensions — 58



# Responds with a wide product range

	HEA Series Solenoid Valves	HEB Series Solenoid Valves (for 2, 3-port valves)
<p><b>Single unit (direct piping)</b></p>	<p>Single solenoid HEA10□F5</p> <p>Double solenoid HEA10□F6</p> <p>p.20</p>	<p>Normally closed (NC) HEB10□F1 HEB10□F3</p> <p>Normally open (NO) HEB10□F2 HEB10□F4</p> <p>p.32</p>
<p><b>Single unit (base piping)</b></p>	<p>Single solenoid HEA10□A5-25</p> <p>Double solenoid HEA10□A6-25</p> <p>p.20</p>	<p>Normally closed (NC) HEB10□A1-25 HEB10□A3-25</p> <p>Normally open (NO) HEB10□A2-25 HEB10□A4-25</p> <p>p.32</p>
<p><b>F type manifold (direct piping type)</b></p>	<p>Manifold with combined mounting of 2, 3, 5-port valves HEAM□F</p> <p>p.22</p>	<p>Manifold for 2, 3-port valves HEBM□F</p> <p>p.33</p>
<p><b>A, AJ type manifold (base piping type)</b></p>	<p>Manifold with combined mounting of 2, 3, 5-port valves HEAM□A HEAM□AJ</p> <p>p.22</p>	<p>Manifold for 2, 3-port valves HEBM□A HEBM□AJ</p> <p>p.33</p>
<p><b>Function-specific solenoids (for both HEA and HEB series)</b></p> <ul style="list-style-type: none"> <li>● Standard type, low current type and quick response type can be identified by the color of the housing.</li> </ul>	<p>Standard type: Blue</p> 	<p>Low current type: Light blue</p> 
		<p>Quick response type: White</p> 

**Easy-to-use, simple configuration!**  
**Responsive to varied needs and professional control, while achieving still lower power consumption levels, quick response and large flow rate!**

# New Standard Valve **HJC/HJE Series Solenoid Valves** (2, 3, 5-port pilot type solenoid valves)

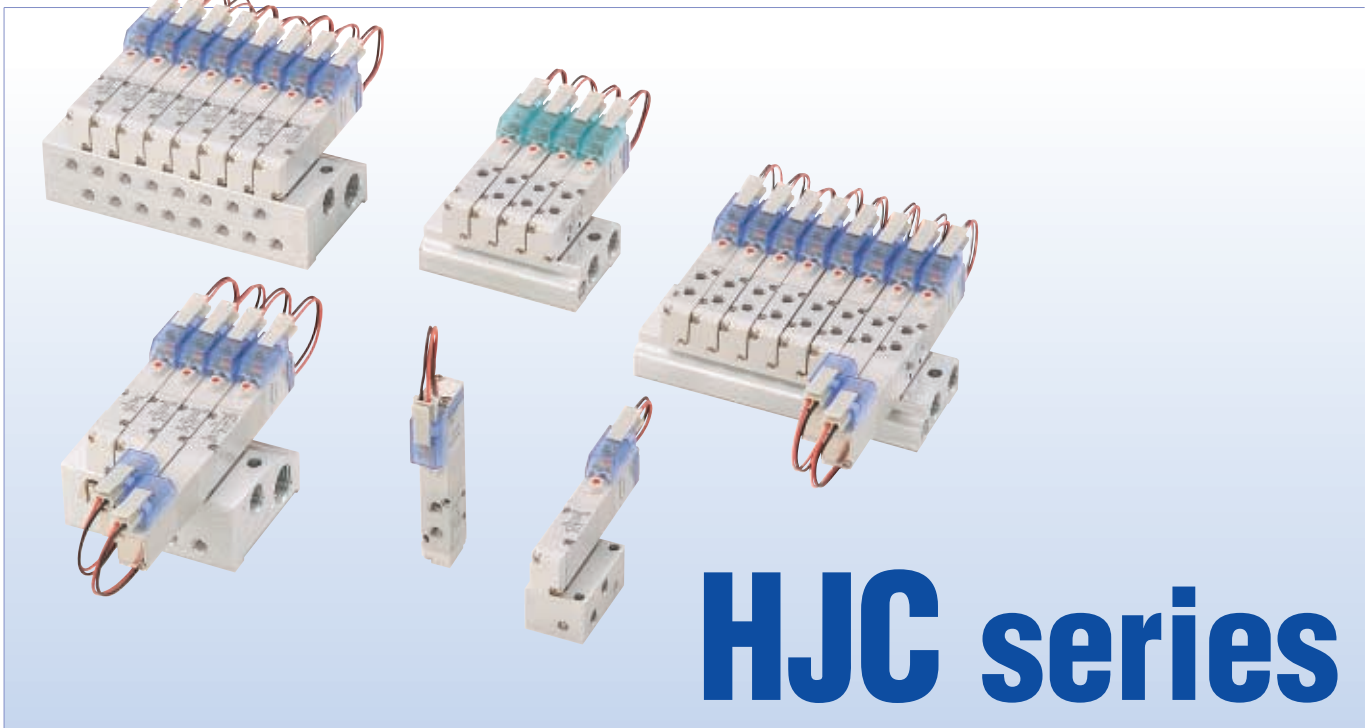

## HJC series

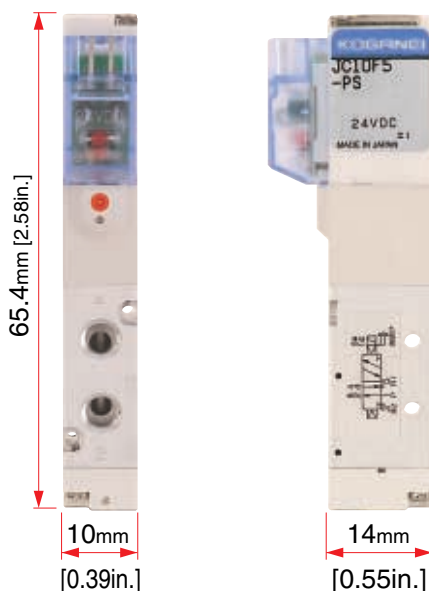

- **Space Assist—Thin and compact size**  
 Valve width: 10mm [0.39in.]  
 Valve length: 65.4mm [2.58in.]
- **Range Assist—Large flow rate with compact body**  
 Sonic conductance C: 0.6dm<sup>3</sup>/(s·bar)  
 (Effective area S: 3.0mm<sup>2</sup> [Cv: 0.17])  
 Optimum for operating up to  $\phi$  40 [1.58in.] bore size cylinders.
- **Response Assist—Achieves quick response**  
 Response time: When ON, max. 6ms  
 When OFF, max. 7ms  
 (for quick response type single solenoid)
- **Power Assist—Achieves lower power consumption**  
 Standard type: 0.55W, Low current type: 0.15W

**Caution** Always read the “Safety Precautions” on page 6 before use.

Provides sure assistance to all factors where solenoid valves are required, on the manufacturing line, or in machinery or equipment. A NEW standard in compact valves!

● **Reliability Assist – Improved reliability**

New solenoid configuration and stem configuration congregating valve technology have boosted working life, response, and other basic performance.

● **Environment Assist – Improved environmental tolerance**

Grommet type offers moisture-proof specifications.  
(for both HJC and HJE series)



● **Option Assist – Mountable on DIN rail**

The A type manifold (base piping type) can be mounted on DIN rail.  
(for both HJC and HJE series)

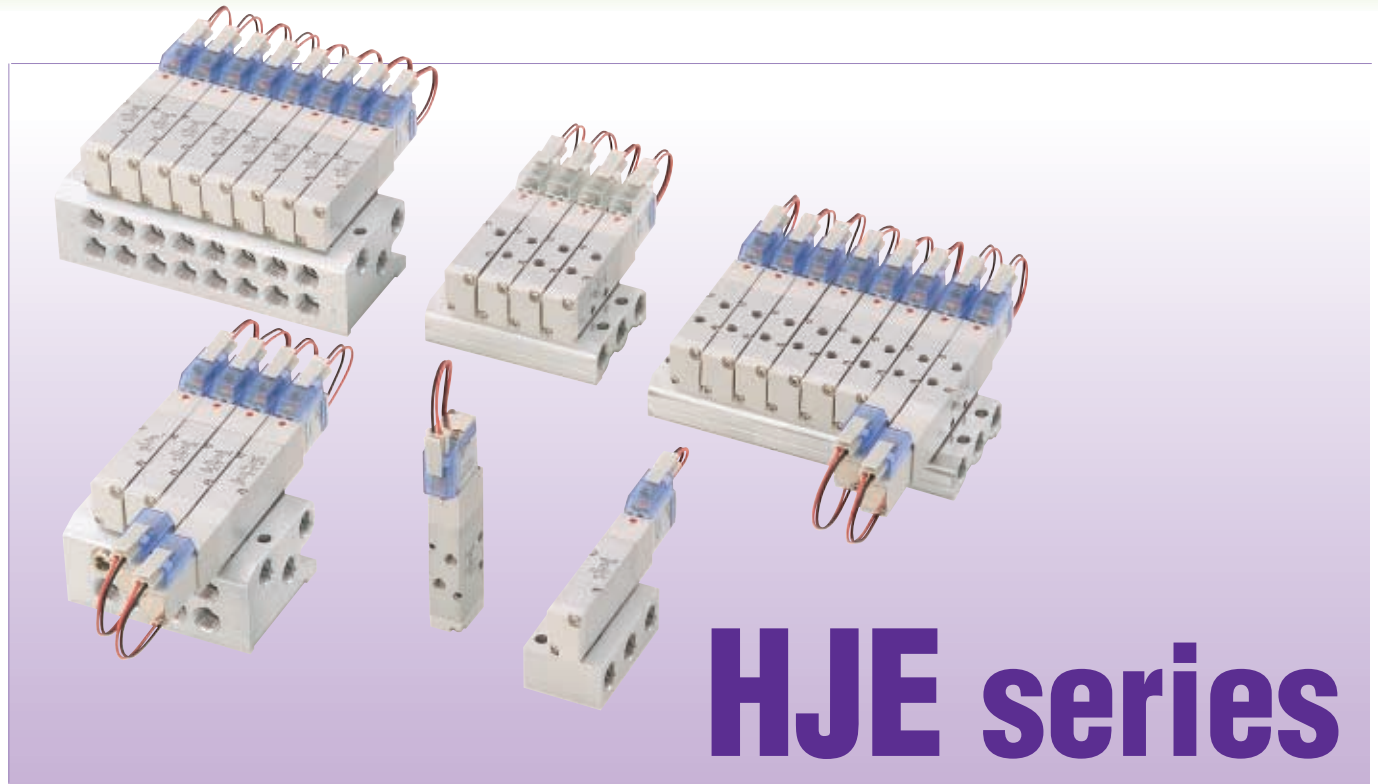

# HJE series

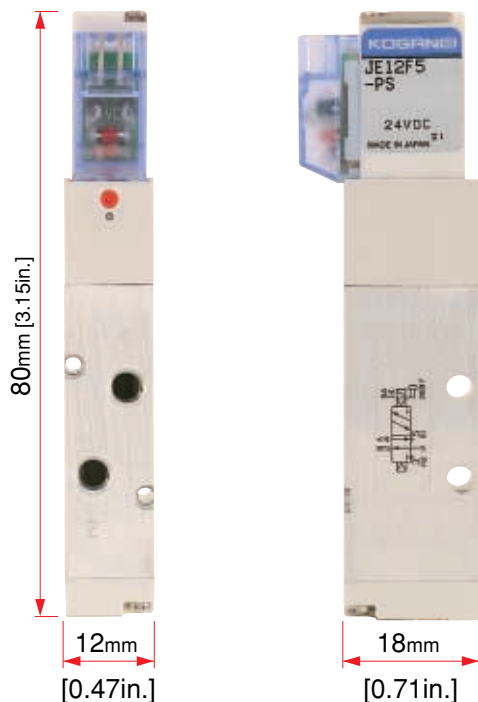

● **Space Assist – Thin and compact size**

Valve width: 12mm [0.47in.]  
Valve length: 80mm [3.15in.]

● **Range Assist – Large flow rate with compact body**

Sonic conductance C: 1.9dm<sup>3</sup>/(s-bar)  
(Effective area: 9.5mm<sup>2</sup> [Cv: 0.53])  
Optimum for operating up to  $\phi$ 80 [3.15in.] bore size cylinders.

● **Response Assist – Achieves quick response**

Response time: When ON, max. 6ms  
When OFF, max. 10ms  
(for quick response type single solenoid)

● **Power Assist – Achieves lower power consumption**

Standard type: 0.55W, Low current type: 0.15W

● **Safety Assist – Configuration for prevention of erroneous operations**

Configuration boosts safety with inclusion of manual lever-type override to prevent erroneous operations. (HJE series only)

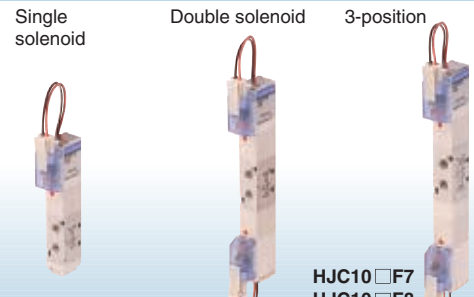
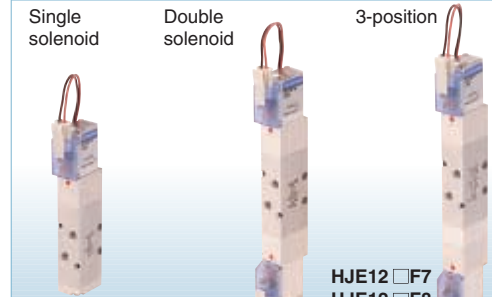
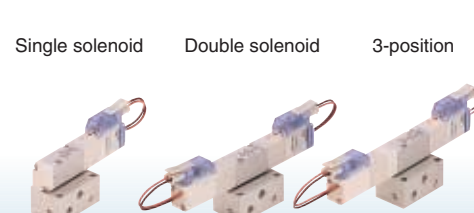
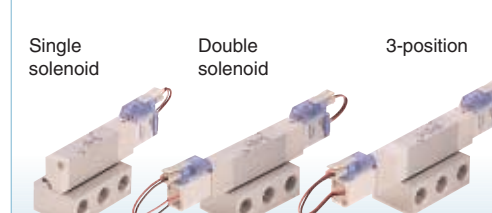
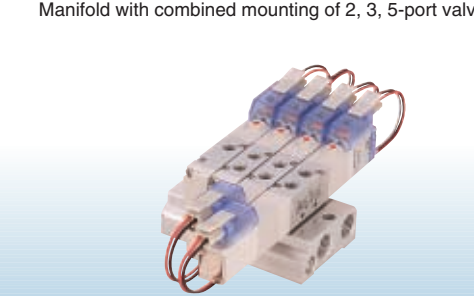
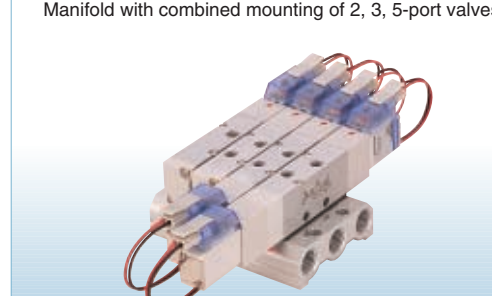
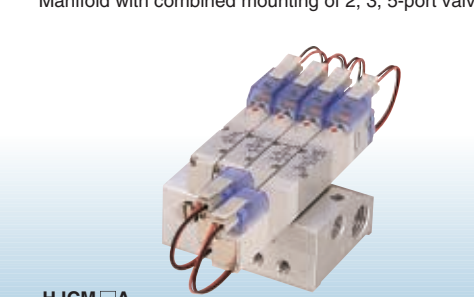
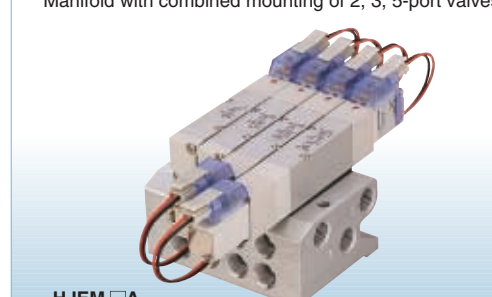

# Responds with a wide product range

	HJC Series Solenoid Valves	HJE Series Solenoid Valves
<b>Single unit (direct piping)</b>	<p>Single solenoid      Double solenoid      3-position</p>  <p>HJC10□F5    HJC10□F6      HJC10□F7 HJC10□F8 HJC10□F9</p> <p>p.44</p>	<p>Single solenoid      Double solenoid      3-position</p>  <p>HJE12□F5    HJE12□F6      HJE12□F7 HJE12□F8 HJE12□F9</p> <p>p.58</p>
<b>Single unit (base piping)</b>	<p>Single solenoid      Double solenoid      3-position</p>  <p>HJC10□A5-25    HJC10□A6-25      HJC10□A7-25 HJC10□A8-25 HJC10□A9-25</p> <p>p.44</p>	<p>Single solenoid      Double solenoid      3-position</p>  <p>HJE12□A5-25    HJE12□A6-25      HJE12□A7-25 HJE12□A8-25 HJE12□A9-25</p> <p>p.58</p>
<b>F type manifold (direct piping type)</b>	<p>Manifold with combined mounting of 2, 3, 5-port valves</p>  <p>HJCM□F</p> <p>p.47</p>	<p>Manifold with combined mounting of 2, 3, 5-port valves</p>  <p>HJEM□F</p> <p>p.61</p>
<b>A type manifold (base piping type)</b>	<p>Manifold with combined mounting of 2, 3, 5-port valves</p>  <p>HJCM□A</p> <p>p.48</p>	<p>Manifold with combined mounting of 2, 3, 5-port valves</p>  <p>HJEM□A</p> <p>p.62</p>



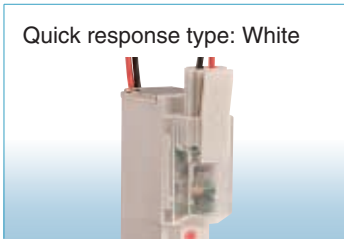
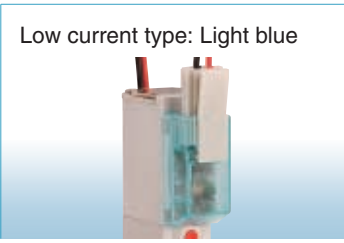
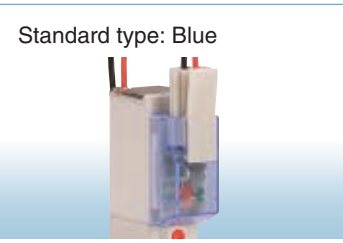

**Function-specific solenoids (for both HJC and HJE series)**

- Standard type, low current type and quick response type can be identified by the color of the housing.



Before selecting and using products, please read all the Safety Precautions carefully to ensure proper product use. The Safety Precautions shown below are to help you use the product safely and correctly, and to prevent injury or damage to assets beforehand. Follow the Safety Precautions for: ISO4414 (Pneumatic fluid power—Recommendations for the application of equipment to transmission and control systems), JIS B 8370 (Pneumatic system regulations)

The directions are ranked according to degree of potential danger or damage: **“DANGER!”** **“WARNING!”** **“CAUTION!”** and **“ATTENTION!”**

 <b>DANGER</b>	Expresses situations that can be clearly predicted as dangerous. If the noted danger is not avoided, it could result in death or serious injury. It could also result in damage or destruction of assets.
 <b>WARNING</b>	Expresses situations that, while not immediately dangerous, could become dangerous. If the noted danger is not avoided, it could result in death or serious injury. It could also result in damage or destruction of assets.
 <b>CAUTION</b>	Expresses situations that, while not immediately dangerous, could become dangerous. If the noted danger is not avoided, it could result in light or semi-serious injury. It could also result in damage or destruction of assets.
 <b>ATTENTION</b>	While there is little chance of injury, this content refers to points that should be observed for appropriate use of the product.

**■ This product was designed and manufactured as parts for use in General Industrial Machinery.**

- Before selecting the equipment and using any product, always read the Safety Precautions, the Catalog, the Instruction Manual, etc.
- After reading the Catalog and Instruction Manual, etc., always place the Manual where it can be easily available for reference to users of this product.
- If transferring or lending the product to another person, always attach the Catalog and Instruction Manual, etc., to the product where it is easily visible, to ensure that the new user can use the product safely and properly.
- The danger, warning, and caution items listed under these “Safety Precautions” do not cover all possible cases. Read the catalog and user’s manual carefully, and always keep safety first.

## DANGER

- Do not use for the purposes listed below:
  1. Medical equipment related to maintenance or management of human lives or bodies.
  2. Mechanical devices or equipment designed for the purpose of moving or transporting people.
  3. Critical safety components in mechanical devices.

This product has not been planned or designed for purposes that require advanced stages of safety. It could cause injury to human life.
- Do not use in locations with or near dangerous substances such as flammable or ignitable substances. This product is not an explosion prevention type. It could ignite or burst into flames.
- When attaching the product, always ensure that it is securely fixed in place. Dropping or falling the product, or improper operation could result in injury.
- Persons who use a pacemaker, etc., should keep a distance of at least one meter (3.3 feet) away from the product. There is the possibility that the pacemaker will malfunction due to the strong magnet built into the product.
- Never attempt to rebuild the product. It could result in abnormal operation leading to injury, electric shock, fire, etc.
- Never attempt inappropriate disassembly or assembly of the product’s basic configurations, or of its performance or functions. It could result in injury, electric shock, fire, etc.
- Do not splash water on the product. Spraying it with water, washing it, or using it underwater could result in malfunction of the product leading to injury, electric shock, fire, etc.
- Do not touch the product or otherwise bring your body into physical proximity with it while it is in operation. Also do not engage in adjustment of the product interior while it is in progress, or of any accessory items (manual override, release or connection of wiring connectors, adjustment of pressure switches, or release or connection of piping tubes or plugs).  
The actuator, etc., could suddenly move, causing personal injury.

## WARNING

- Do not use this product in excess of its specification range. Such use could result in product breakdowns, cessation of function, or damage.
- Before supplying air or electricity to the device and before starting operation, always conduct a safety check of the area of machine operation. Careless supply of air or electricity could possibly result in electric shocks, or in injury caused by contact with moving parts.
- Do not touch the terminal and the miscellaneous switches, etc., while the device is plugged in. There is the possibility of electric shock and abnormal operation.
- Do not allow the product to be thrown into fire. The product could explode and release toxic gases.
- Do not sit on the product, place your foot on it, or place other objects on it. Accidents such as falling and tripping over could result in injury. Dropping the product may damage or break the product resulting in abnormal, improper or erratic operation.
- When conducting any kind of operation for the product, such as inspection, repair, installation/removal of piping, or replacement, always shut off the air supply completely and confirm that residual pressure inside the product or in piping connected to the product is zero before proceeding. In particular, be aware that residual air will still be in the air compressor or air storage tank. The actuator could abruptly move if residual air pressure remains inside the piping, causing injury.
- Before commencing normal operation, always release the lock on the locking type manual override, and confirm that the manual override is in the original position and that the main valve is in the proper switching position, and only then commence the operation. Failure to do so could lead to erroneous operation.
- Always shut off power when performing wiring operations. Leaving the power on could result in electric shocks.
- Use the specified voltage for the solenoid. Using the wrong voltage level will prevent the solenoid from performing its function, and could lead to breakage or burn damage of the product itself.
- Avoid scratching the cords for the sensor switch lead wires, etc. Letting the cords be subject to scratching, excessive bending, pulling, rolling up, or being placed under heavy objects or squeezed between two objects, may result in current leaks or

defective transmission that lead to fires, electric shocks, or abnormal operation.

- Do not pull out the connectors while the power is ON. Also, do not put unnecessary stress on the connector. It could result in erroneous equipment operation that could lead to personal injury, equipment breakdown, or electrical shocks, etc.
- Always check the Catalog to ensure that the product wiring and piping is done correctly. Errors in wiring and piping could lead to abnormal operation of the actuators, etc.
- In initial operations after the equipment has been idle for 48 hours or more, or has been in storage, there is a possibility that contact parts will stick, resulting in equipment operation delays or sudden movements. For these initial operations, always run a test operation before use to check that operating performance is normal.
- In low frequency use (more than 30 days between uses), there is a possibility that contact parts will stick, resulting in equipment operation delays or sudden movements that could lead to personal injury. Run a test operation at a minimum operations frequency of 30 days between tests to confirm that movement is normal.
- In double solenoid configurations, do not apply current through both solenoids simultaneously. It is impossible in such a situation to maintain the correct valve position, and the equipment may operate in an unintended direction, leading to the possibility of equipment breakdown or personal injury.
- Do not use the solenoid valves or the wiring that controls them, near wires where large electrical currents are flowing, or in locations subject to powerful magnetic fields or power surges. Such application could lead to unintended operation.
- Do not use where ozone may be generated, such as near ocean beaches or other places subject to direct sunlight or mercury lamps. Ozone can cause rubber parts to deteriorate, which can lead to degraded performance and functions, or to equipment stoppages. (Excludes items where measures against ozone have been taken.)
- Do not use any media other than shown on the specifications. Use of non-specified media could lead to functional shutdown after a short period, to sudden performance drops, or to shorter operating life.
- If mounting the solenoid valve inside a control panel, or if energizing it for long periods, provide heat radiation measures to ensure that temperatures surrounding the solenoid valve always remain within the specified temperature range. If energizing the unit for long periods, consult with Humphrey Products.
- After wiring operations, always check to ensure that no wiring connection errors exist before turning on the power.

### CAUTION

- When mounting the product, leave room for adequate working space around it. Failure to assure adequate working space will make it more difficult to conduct daily inspections or maintenance, which could eventually lead to system shutdown or damage to the product.
- When transporting or installing heavy products, use a lift or support to firmly hold it up, or use a large number of people, and take full precautions to ensure personal safety.
- Do not bring floppy disks or other magnetic media within one meter (3.3 feet) of a solenoid valve when current is passing through it. The magnetic force could damage the data on the floppy disk, etc.
- If leakage current is occurring in the control circuit, there is a possibility of the product performing an unintended operation. Take measures against current leaking in the control circuit, to ensure that the leakage current value does not exceed the allowed range in the product specifications.
- Do not block the product's breathing holes. This will result in pressure changes due to changes in volume during operation. Blocking the breathing holes destroys the pressure balance, and could cause failure of the intended operation, equipment damage, or personal injury.

- Do not use the solenoid valve in locations subject to large electrical currents or magnetic fields. It could result in erroneous operation.
- Oily materials from the compressor (excluding the oil-free compressor) can cause drastic deterioration in product performance, and even a functional shutdown. Always install a mist filter before pneumatic equipment to remove the oily component.
- The properties of the lubrication oil can change if using in dry air where dew point temperatures is lower than -20°C (-4°F). It could result in degraded performance or in functional shutdown.
- Do not use in locations under direct sunlight (ultraviolet), in locations with high temperature and humidity, in locations subject to dust, salt, or iron powder, or in the media and/or the ambient atmospheres that include organic solvents, phosphoric acid ester-based hydraulic oil, sulfur dioxide gas, chlorine gas and acids. These conditions could lead to functional shutdowns, sudden degraded performance, or shortened operating life in a brief period of time. For the materials used, see Major Parts and Materials.

### ATTENTION

- When considering the possibility of using this product in situations or environments not specifically noted in the Catalog or Instruction Manual, or in applications where safety is an important requirement, such as in an airplane facility, combustion equipment, leisure equipment, safety equipment and other places where human life or assets may be greatly affected, take adequate safety precautions such as application with enough margins or fail-safe measures for ratings and performance. Please consult with Humphrey Products about any questions.
- Always check the Catalog and other reference materials for product wiring and piping.
- Install a muffler, etc., on the exhaust port. It is effective in reducing exhaust noise.
- When handling the product, wear protective gloves, safety glasses, safety boots, etc., to ensure safety.
- When the product can no longer be used, or is no longer necessary, dispose of it appropriately as industrial waste.
- Pneumatic equipment can deliver degraded performance and function over its operating life. Always conduct daily inspections of the pneumatic equipment, and confirm that all required system functions are satisfied, to prevent accidents from happening.
- Air leaks from the valve are not zero. For application of requiring holding pressure (including vacuum) inside the pressurized reservoir, consider adequate margin of capacity and holding time in design of the system.
- For inquiries about the product, see your nearest Humphrey Products sales office.

### OTHER

- Always observe the following items.
  1. When using this product in pneumatic systems, always use genuine Humphrey Products parts or compatible parts (recommended parts).  
When conducting maintenance and repairs, always use genuine Humphrey Products parts or compatible parts (recommended parts). Always observe the required methods.
  2. Do not attempt inappropriate disassembly or assembly of the product relating to basic configurations, or its performance or functions.

Humphrey Products cannot be responsible if these items are not properly observed.





## General precautions

### Mounting

1. While any mounting direction can be allowed, avoid directly applying shocks or vibrations on the valves.
2. Avoid using in the locations and environments listed below because they could result in valve breakdowns. If you must use in such conditions, always provide a cover and take other adequate protective measures.
  - Locations where the valve is directly subjected to dripping water or oil, etc.
  - Environments where moisture condenses on the valve body.
  - Locations where the valve is directly subjected to metal chips or dust.
3. Always thoroughly blow off (use compressed air) the piping before connecting it to the valve.

Entering chips, sealing tape, rust, etc., generated during piping work could result in air leaks or other defective operation.
4. The valve cannot be used with the 4 (A) and 2 (B) ports left open.
5. If mounting the valve inside a control panel, or if energizing it for long periods of time, provide air ventilation or other methods to effectively radiate the heat.

### Media

1. Use air for the media. For the use of any other media, consult with Humphrey Products.
2. Use clean air that does not contain deteriorated compressor oil or other contaminants. Install an air filter (with filtration of 40  $\mu\text{m}$  or less) close to the valve to catch any airline condensate or dust. Moreover, clean the air filter at regular intervals.
3. When the supplied pressure is low, use piping with a sufficiently large diameter for the 1 (P) port tube.

### Lubrication

While the system can be used without lubrication, if you must use oil for the actuators, etc., use Turbine Oil Class 1 (ISO VG32) or an equivalent.

Avoid using spindle oil or machine oil. Also be aware that excessive amounts of lubricating oil can result in defective operation.

### Atmosphere

The product cannot be used when the media or the ambient atmosphere contains any of the substances listed below.

Organic solvents, phosphoric acid ester-based hydraulic oil, sulfur dioxide gas, chlorine gas, or acids, etc.

### Wiring

Upon completion of wiring work, always check to confirm that no wiring misconnection exists.

### Prevention of erroneous operation in the manifold type

Whenever using the manifold type valve, such as operating air cylinder or performing air blow work, defective operation due to errors caused by the exhaust or to inadequate flow rate could occur. Take the countermeasures listed below before starting use of the manifold type.

#### 1. Erroneous operation due to large exhaust flow rate

**Cause:** When using large bore cylinders or simultaneous operation of a number of cylinders, the pressure of the collected exhaust can cause the exhaust to flow back through the exhaust ports of other solenoid valves, obstructing the operations of other cylinders, or could cause the air in single-acting cylinders or air hands, etc., to flow backward, causing errors in operation. The cause is insufficient exhaust (large exhaust resistance) in the manifold.

**Countermeasure:** To reduce exhaust resistance, open the exhaust ports on both ends. If there is still an exhaust interference even exhausting on both ends, split the manifold.

#### 2. Defective operation due to insufficient pressure or flow rate

**Cause:** If using a manifold type for operating a large bore cylinder or simultaneous operation of multiple cylinders, or for circuits for blowing air, etc., sudden large consumption of air could result in insufficient flow into the neighboring cylinder, causing a drop in speed or a shortage of cylinder thrust. Moreover, in the pilot type valve, insufficient pressure for the pilot signal can lead to erroneous operation of the stem.

**Countermeasure:** To prevent air supply shortage to the manifold, supply air from 1(P) ports on the both ends of the manifold. For air blowing, either separate the air lines and use individually, or consider using an external pilot valve.



## Solenoid

### Internal circuit

#### ●12VDC, 24VDC

(Standard type)

Solenoid with LED indicator and surge suppression

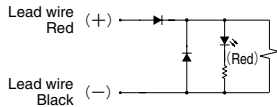

#### ●24VDC

(Low current, quick response types)

Solenoid with LED indicator and surge suppression

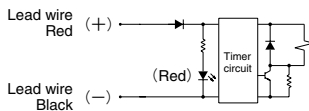

- Cautions:**
1. Do not apply megger between the pins.
  2. Leakage current inside the circuit could result in failure of the solenoid valve to return to the rest position or in other erratic operation. Always use at less than the allowable leakage current shown in the solenoid specifications on p.13, 25, 37 and 51. If circuit conditions, etc., cause the leakage current to exceed the maximum allowable leakage current, consult us.
  3. For the double solenoid specification, avoid energizing both solenoids simultaneously.
  4. The standard housing type is colored blue, while the low current type is light blue, and the quick response type is white.
  5. The low current type and quick response type will not activate if the power supply voltage is raised slowly. Always apply the appropriate voltage.

### Operating principles of low current and quick response type

The low current and quick response type use a timer circuit, as shown in the above, that achieves power savings by switching to holding operations mode after a certain period of time to operate at about 1/3 of the start-up power consumption.

#### ●Power cycle for low current type

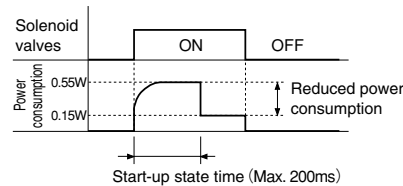

#### ●Power cycle for quick response type

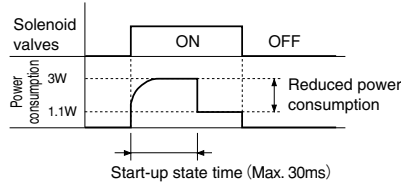

## Plug connector

### Attaching and removing plug connector

Pick up connector with fingers to insert it into the pin, push in until the lever claw catches the convex section on the connector housing, and complete the connection.

To remove the connector, squeeze the lever along with the connector, lift the lever claw up from the convex section on the housing, and pull out.

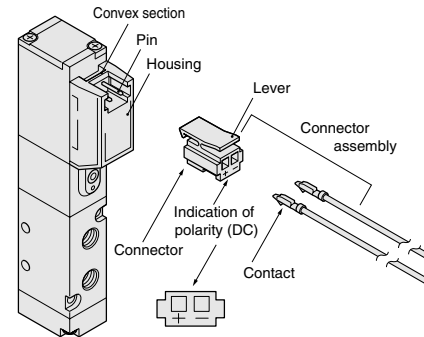

### Crimping of connecting lead wire and contact

To crimp lead wires into contacts, strip off 4mm [0.16in.] of the insulation from the end of the lead wire, insert into the contact, and crimp it. Be sure to avoid catching the insulation on the expose wire crimping section.

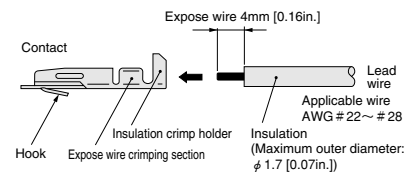

- Cautions:**
1. Do not pull the lead wire too hard.
  2. Always use the dedicated tool for crimping of connecting lead wire and contact.  
Contact: Model 702062-2M  
Manufactured by Sumiko Tech, Inc.  
Crimping tool: Model F1-702062  
Manufactured by Sumiko Tech, Inc.

### Attaching and removing connector and contact

Insert the contact with a lead wire into a connector □ hole until the contact hook catches and is secured to the connector. Confirm that the lead wire cannot be easily pulled out.

To remove, insert a tool with a fine tip (such as a small screwdriver) into the rectangular hole on the side of the connector to push up on the hook of the contact, and then pull out the lead wire.

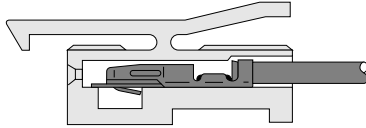

- Cautions:**
1. Do not pull the lead wire too hard. It could result in defective or lost connections.
  2. If the pins are bent, use a small screwdriver to gently bend the pins back to a straight position, and then attach the connector to the device.



### Precautions for side mounting (HJE series)

If using a unit in the solenoid valve HJE series in a side mounting, as shown in the diagram below, mounting base-22 for side mounting is required because the fitting interferes with the mounting surface. Note that quick fitting standard types **TS6-M5** and **TL6-M5** for the 6mm [0.24in.] tube cannot be mounted. Use the hexagon socket straight fitting or the quick fitting mini type instead.

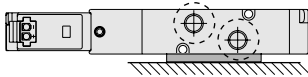

## Manual override

### Non-locking type

To operate, press the manual override all the way down.

In the single solenoid, the valve works the same as an energized state as long as the manual override is pushed down, and returns to the rest position upon release.

In the double solenoid, pressing the manual override on the 14 (SA) side switches the state of the 14 (SA) to energized state, and the unit remains in that state even after the manual override is released. To return to the rest position, operate the manual override on the 12 (SB) side. This is the same for solenoid 12 (SB).

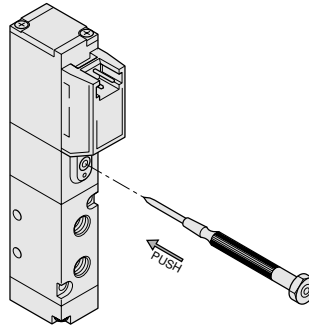

### Locking type

To lock, use a small screwdriver to push down on the manual override all the way down and turn it clockwise 45 degrees. When locked, turning the manual override 45 degrees in a counterclockwise direction returns it to its original position, and releases the lock. (Excluding the quick response type)

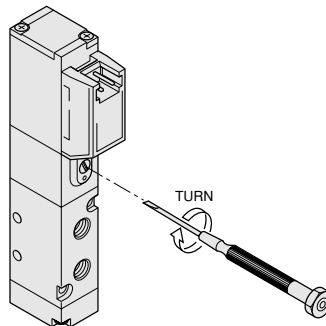

### Lever type (HJE series only)

To lock, push down on the manual lever all the way down and turn it clockwise 90 degrees. When locked, turning the manual lever 90 degrees in a counterclockwise direction returns it to its original position, and releases the lock. If the manual lever is never turned, this type acts just like the non-locking type, like the valve energizing status as long as the manual lever is pushed down, and returning to the rest position upon release.

To avoid inadvertently pushing in the manual lever, a safety plate is provided for prevention of erroneous operations. Note that the safety plate cannot be operated when the manual lever is locked in place.

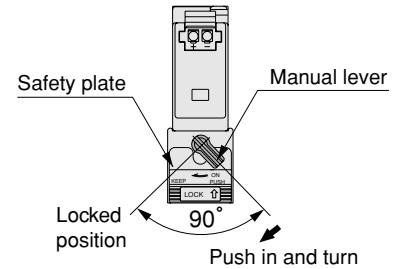

### ● Safety plate operating method

- ① Check that the manual lever is in the off position.
- ② Slide the center of the safety plate in the direction shown by the arrow until it comes to a stop, a distance of about 3mm [0.12in.]. In this position, the manual lever can no longer be pushed in.
- ③ To release the safety plate, slide it in the direction opposite to that shown by the arrow, until it comes to a stop.

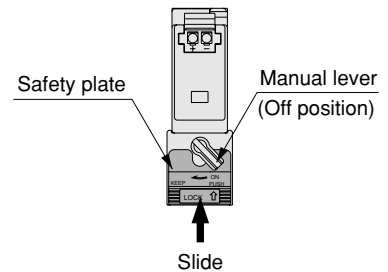

- Cautions:**
1. The HEA, HEB, HJC, and HJE series are pilot type solenoid valves. As a result, the manual override on manual lever cannot switch the main valve without supplying air from the 1(P) port.
  2. Always release the lock on the manual override or manual lever before commencing normal operation.
  3. Do not attempt to operate the manual override on the manual lever with a pin or other object having an extremely fine tip.
  4. For the lever type, do not apply more force than is necessary when sliding the safety plate. It could result in an accident. (Recommended force: 3N)

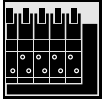

## Manifold

### Mounting on a DIN rail (A type manifold)

A mounting bracket and fixing screw are provided for mounting on the DIN rail. First of all, use the fixing screw to temporarily hold the mounting bracket on the manifold.

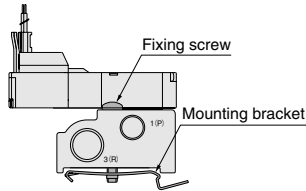

### ● Mounting

- Approaching from the direction shown in the diagram, let the mounting bracket hook catch on the DIN rail claw, then press down on the manifold to insert the tool into the DIN rail.

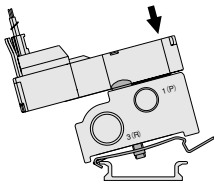

- To ensure that the mounting bracket is firmly set against the bottom of the manifold, tighten the fixing screw to fix the DIN rail in place.  
Recommended tightening torque:  
98N·cm {10kgf·cm} [8.66lbf·in.]

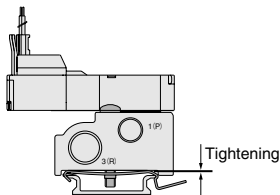

**Caution:** Since the mounting bracket cannot slide along the DIN rail once it is set into the rail, be sure to set the manifold in the desired position beforehand.

### ● Removing

- Loosen the fixing screw and lift off the manifold away from the mounting bracket.
- Insert a flat screwdriver, etc., underneath the mounting bracket's release lever, and gently lift up on the release lever to remove the mounting bracket.

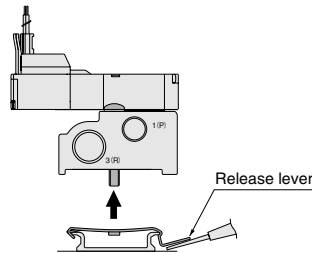

**Cautions:** A pent-up reaction force from the mounting bracket's plate spring could cause the tool to fly off during the removal operation. To ensure safety, proceed with caution during the operation. In addition, always use a flat screwdriver when removing the mounting bracket from the DIN rail. Never perform the operation using your fingers because of the danger of serious injury due to the strong forces that may be applied.

### ● Perpendicular mounting

When mounting the manifold in a perpendicular position, mount it so that the release lever is pointing downward.

**Caution:** Be careful to avoid dropping the manifold.

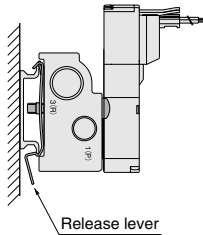

### Mounting a valve on the manifold

If mounting a valve on the manifold, the recommended tightening torque for the valve mounting screw is 14.7N·cm {1.5kgf·cm} [1.30lbf·in.].

### Tube

#### 1. Attaching and removing tubes

For tube connection, insert an appropriate size tube as far as contacting with the tube stopper, and lightly pull it to check the connection.

For tube removal, push the tube against the tube stopper, then push the release ring and at the same time pull the tube out.

#### 2. Either a nylon tube or urethane tube can be used.

Use tubes with an outer diameter tolerance within  $\pm 0.1\text{mm}$  [0.004in.] of the nominal diameter, and allowance of out-of-ellipticity (difference between large diameter and small diameter) is 0.2mm [0.008in.] or less. (Using Humphrey Products tubes is recommended.)

- Cautions:**
- Do not use extra-soft tubes since their pull-out strength reduces significantly.
  - Only use tubes without scratch on the outer surface. If scratch is made during repeated use, cut off the scratched section.
  - Do not bend the tube excessively near the fittings. The minimum bending radius is as shown in the table below.
  - When attaching or removing tubes, always stop air supply. In addition, always confirm that air has been completely exhausted from the manifold.

Tube size	Minimum bending radius	
	Nylon tube	Urethane tube
$\phi 3$ [0.118]	—	7 [0.3]
$\phi 4$ [0.157]	20 [0.8]	10 [0.4]
$\phi 6$ [0.236]	30 [1.2]	15 [0.6]
$\phi 8$ [0.315]	50 [2.0]	20 [0.8]

# HEA Series Solenoid Valves

# HEA

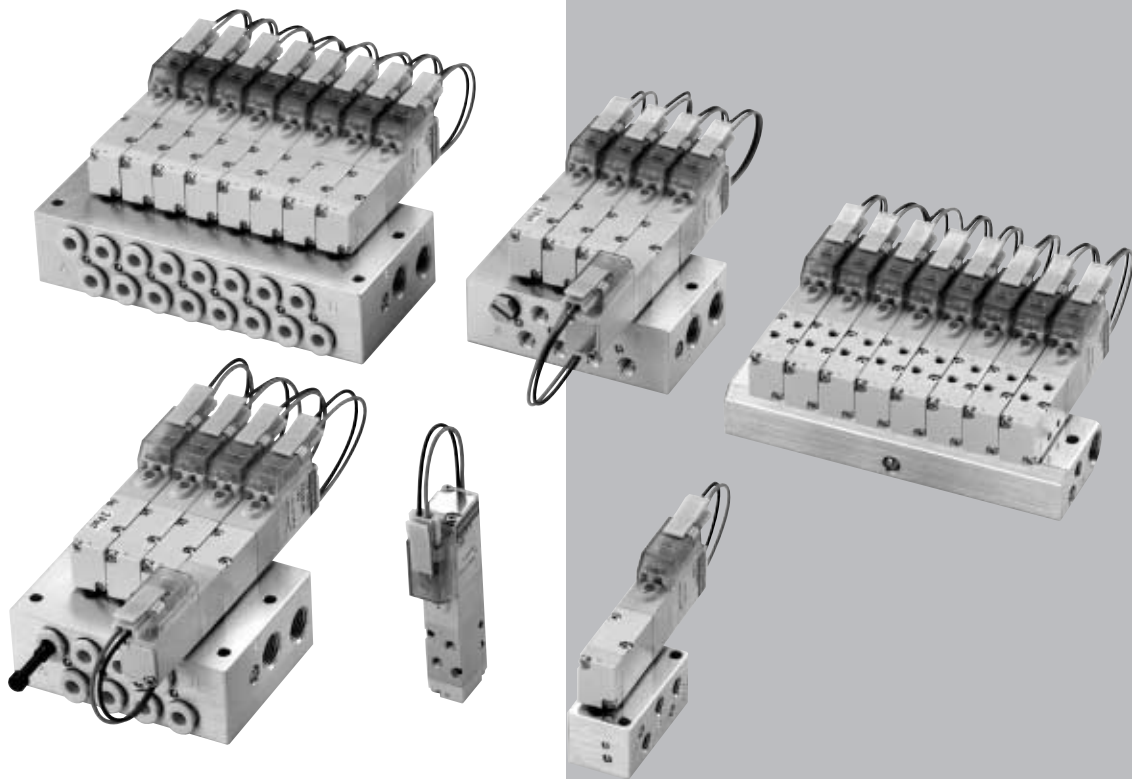

# HEA SERIES SPECIFICATIONS

## Specifications

### Basic Models and Functions

Item	Basic model	For direct piping and F type manifold	HEA10□F1 <sup>Note</sup> HEA10□F2 <sup>Note</sup> HEA10□F3 <sup>Note</sup> HEA10□F4 <sup>Note</sup>	HEA10□F5	HEA10□F6
		For base piping and A, AJ type manifold	HEA10□A1 <sup>Note</sup> HEA10□A2 <sup>Note</sup> HEA10□A3 <sup>Note</sup> HEA10□A4 <sup>Note</sup>	HEA10□A5	HEA10□A6
Number of positions		2 positions			
Number of ports		2, 3 ports	5 ports		
Valve function		Single solenoid NC, NO	Single solenoid	Double solenoid	

Remark: For the optional specifications and order code, see p.17.

Note: Valves with valve specifications F1, F2, F3, F4, A1, A2, A3, and A4 are for mounting on manifolds only, and cannot be used as a single valve unit.

### Specifications

Item	Basic model	For direct piping and F type manifold	HEA10□F1 HEA10□F2 HEA10□F3 HEA10□F4	HEA10□F5	HEA10□F6
		For base piping and A, AJ type manifold	HEA10□A1 HEA10□A2 HEA10□A3 HEA10□A4	HEA10□A5	HEA10□A6
Media		Air			
Operation method		Internal pilot type			
Flow rate characteristics <sup>Note 1</sup>	Sonic conductance C dm <sup>3</sup> /(s·bar)	Base piping (A, AJ type): 0.26			
	Effective area S mm <sup>2</sup> [Cv]	Direct piping (F type): 1.3 [0.07]			
Port size <sup>Note 2</sup>		M3×0.5			
Lubrication		Not required			
Operating pressure range MPa [kgf/cm <sup>2</sup> ]		0.2~0.7 {2~7.1} [29~102psi.]			
Proof pressure MPa [kgf/cm <sup>2</sup> ]		1.05 {10.7} [152psi.]			
Response time <sup>Note 3</sup> ON/OFF ms	Standard type	Max. 10/20		Max. 12	
	Low current type (L)	Max. 10/50		Max. 12	
	Quick response type (S)	Max. 6/7		Max. 6	
Maximum operating frequency Hz	Standard type	5			
	Low current type (L)	2			
	Quick response type (S)	10			
Minimum time to energize for self holding <sup>Note 4</sup> ms		—		50	
Operating temperature range (atmosphere and media) °C [°F]		5~50 [41~122]			
Shock resistance m/s <sup>2</sup> [G]		1373.0 {140} (Axial direction 294.2 {30})		1373.0 {140} (Axial direction 147.1 {15})	
Mounting direction		Any			

Notes: 1. For details, see the flow rate characteristics on p.14.

2. For details, see the port size on p.14.

3. Values when air pressure is 0.5MPa [73psi.].

4. For double solenoid valve.

### Solenoid Specifications

Item	Rated voltage	5VDC (Standard type)		6VDC (Standard type)		12VDC (Standard type)		24VDC (Standard type)		24VDC (Low current type)		24VDC (Quick response type)		
		4.5~5.5 (5±10%)		5.4~6.6 (6±10%)		10.8~13.2 (12±10%)		21.6~26.4 (24±10%)		21.6~26.4 (24±10%)		21.6~26.4 (24±10%)		
Operating voltage range	V	4.5~5.5 (5±10%)		5.4~6.6 (6±10%)		10.8~13.2 (12±10%)		21.6~26.4 (24±10%)		21.6~26.4 (24±10%)		21.6~26.4 (24±10%)		
Standard type	Current (When rated voltage is applied) mA (r.m.s)	110		92		46		23		—		—		
	Power consumption W	0.55		0.55		0.55		0.55		—		—		
Low current type Quick response type	Current (When rated voltage is applied)	Starting mA	—		—		—		—		23		125	
		Holding mA	—		—		—		—		6.3		46	
	Power consumption	Starting W	—		—		—		—		0.55		3	
		Holding W	—		—		—		—		0.15		1.1	
	Start-up time (standard time) ms	—		—		—		—		Max. 200		Max. 30		
	Allowable leakage current mA	4.8		4		2		1		0.5		4		
Insulation resistance MΩ	Min. 100 (value at 500VDC megger)													
Color of LED indicator	Red													
Surge suppression (as standard)	Flywheel diode													

## Port Size

Specifications	Ports	2(B), 4(A)	1(P)	3·5(R)	PR
Single unit	Direct piping	M3×0.5	M3×0.5	M3×0.5	—
	Base piping (with sub-base)	10-32UNF	10-32UNF	10-32UNF	10-32UNF
Manifold	F type	M3×0.5	10-32UNF	1/8NPT	—
	A type	10-32UNF	1/8NPT	1/8NPT	Assemble at 3·5 (R) port
	AJ type	Quick fitting for 5/32 [0.157in.]	1/8NPT	1/8NPT	

## Flow Rate Characteristics

The test method for flow rate characteristics conforms to JIS B 8390:2000 (test method for air pressure — equipment for compressible fluids — flow rate characteristics).

### ● When using as a single unit

Basic model		Flow channel	Sonic conductance C [dm <sup>3</sup> /(s·bar)]	Critical pressure ratio b	Effective area S [mm <sup>2</sup> ] [Cv]	
Direct piping	HEA10□F5 HEA10□F6	1 (P) → 4 (A)	—	—	1.30 [0.07]	0.75 [0.04] <sup>Note 1</sup> (with fitting)
		1 (P) → 2 (B)	—	—		
		4 (A) → 5 (R1)	—	—		
		2 (B) → 3 (R2)	—	—		
Base piping (with sub-base)	HEA10□A5 HEA10□A6	1 (P) → 4 (A)	0.26	0.17	1.30 [0.07] <sup>Note 3</sup>	
		1 (P) → 2 (B)	0.22	0.00	1.10 [0.06] <sup>Note 3</sup>	
		4 (A) → 5 (R1)	0.26	0.17	1.30 [0.07] <sup>Note 3</sup>	
		2 (B) → 3 (R2)	0.26	0.12	1.30 [0.07] <sup>Note 3</sup>	

### ● When mounted on a manifold

Basic model		Flow channel	Sonic conductance C [dm <sup>3</sup> /(s·bar)]	Critical pressure ratio b	Effective area S [mm <sup>2</sup> ] [Cv]					
F type manifold (direct piping type)	HEA10□F1 HEA10□F2 HEA10□F3 HEA10□F4 HEA10□F5 HEA10□F6	1 (P) → 4 (A)	—	—	1.30 [0.07]	0.80 [0.05] <sup>Note 2</sup> (with fitting)				
		1 (P) → 2 (B)	—	—						
		4 (A) → 5 (R1)	—	—						
		2 (B) → 3 (R2)	—	—						
		A, AJ type manifold (base piping type)	HEA10□A1 HEA10□A2 HEA10□A3 HEA10□A4 HEA10□A5 HEA10□A6	1 (P) → 4 (A)			0.26	0.12	1.30 [0.07] <sup>Note 3</sup>	
				1 (P) → 2 (B)			0.26	0.18	1.30 [0.07] <sup>Note 3</sup>	
4 (A) → 5 (R1)	0.25			0.26	1.25 [0.07] <sup>Note 3</sup>					
2 (B) → 3 (R2)	0.26			0.20	1.30 [0.07] <sup>Note 3</sup>					

Notes: 1. Quick fitting TS3-M3M has been mounted on connection ports 1(P), 2(B), and 4(A).

2. Quick fitting TS3-M3M has been mounted on connection ports 2(B), and 4(A).

3. Figures in effective area S calculated based on sonic conductance C (S=5.0×C).

**Base piping type**  
(Effective area S = 1.3mm<sup>2</sup> [Cv: 0.07])

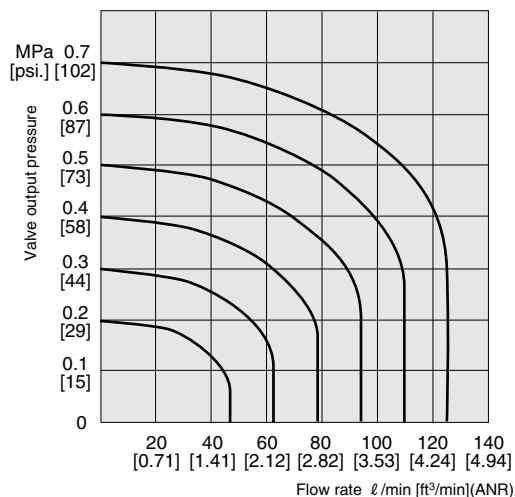

**Direct piping type with fitting**  
(Effective area S = 0.75mm<sup>2</sup> [Cv: 0.04])

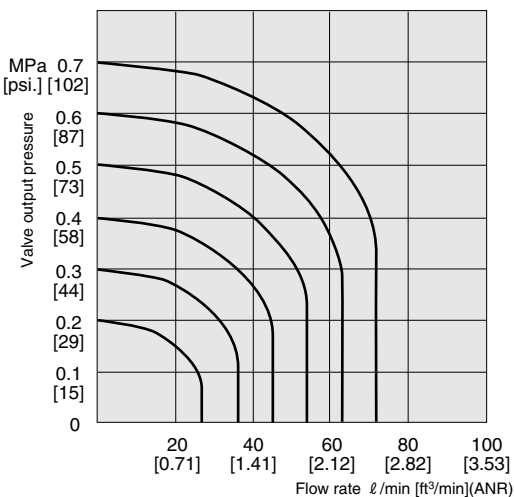

- Graphs use flow rate calculations based on the radiation method.
- Treat the flow rate as a general standard.

## Mass

### Single Valve Unit Mass

g [oz]

Basic model	Mass	Additional mass	
		-21 (with bottom mounting base)	-25 (with sub-base)
HEA10□F1	23 [0.81]	—	—
HEA10□F2	23 [0.81]		
HEA10□F3	23 [0.81]		
HEA10□F4	23 [0.81]		
HEA10□F5	23 [0.81]		
HEA10□F6	38 [1.34]		
HEA10□A1	23 [0.81]	—	—
HEA10□A2	23 [0.81]		
HEA10□A3	23 [0.81]		
HEA10□A4	23 [0.81]		
HEA10□A5	23 [0.81]		
HEA10□A6	38 [1.34]		

### Manifold Mass

g [oz]

Basic model	Mass calculation of each unit (n=number of units)	Block-off plate
HEAM□F	$(9 [0.32] \times n) + 15 [0.53]$	3 [0.11]
HEAM□A	$(18 [0.63] \times n) + 38 [1.34]$	4 [0.14]
HEAM□AJ	$(27.5 [0.97] \times n) + 50 [1.76]$	4 [0.14]

Calculation example: HEAM8AJ

stn.1~8 HEA10A5-PS-D4

$$(27.5 \times 8) + 50 + (23 \times 8) = 454\text{g}$$

$$[(0.97 \times 8) + 1.76 + (0.81 \times 8)] = 16.00\text{oz}$$



**5-port, 2-position**

**Single solenoid**

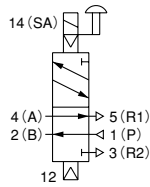

**Double solenoid**

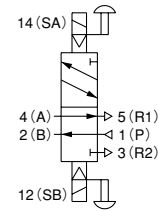

**HEA10F5**  
De-energized

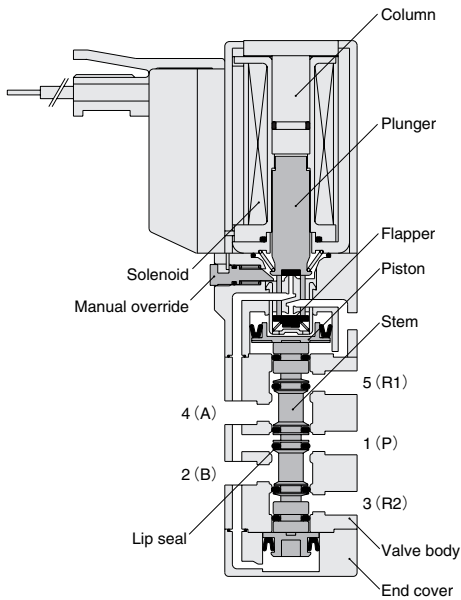

**HEA10F6**  
[De-energized condition after energizing solenoid 12 (SB)]

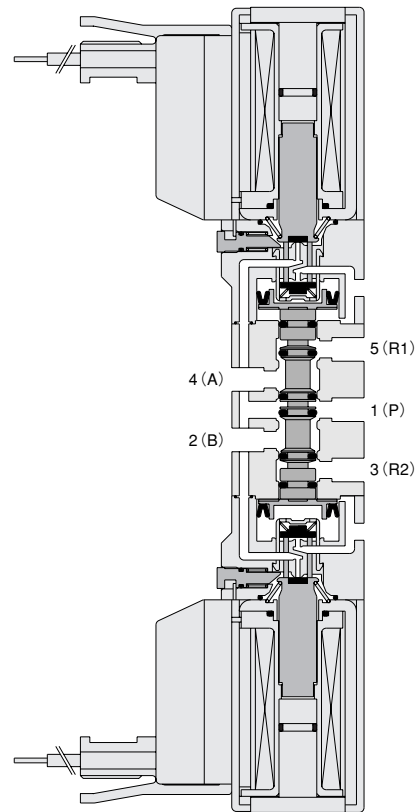

**Major Parts and Materials**

	Parts	Materials
Valve	Body	Aluminum alloy
	Stem	(anodized)
	Lip seal	Synthetic rubber
	Flapper	
	Mounting base	Steel (zinc plated)
	Sub-base	Aluminum alloy (anodized)
	Plunger	Magnetic stainless
	Column	
	End cover	
Manifold	Body	Aluminum alloy (anodized)
	Block-off plate	Steel (nickel plated)
	Seal	Synthetic rubber

# HEA Series Single Valve Unit Order Code



## Model

**HEA10**

Standard type

**HEA10L**

Low current type

**HEA10S**

Quick response type

## Valve specification

**F1, A1:** 2-port normally closed (NC)<sup>Note 1</sup>

**F2, A2:** 2-port normally open (NO)<sup>Note 1</sup>

**F3, A3:** 3-port normally closed (NC)<sup>Note 1</sup>

**F4, A4:** 3-port normally open (NO)<sup>Note 1</sup>

**F5, A5:** 5-port 2-position, single

**F6, A6:** 5-port 2-position, double

## Mounting base

Without mounting base

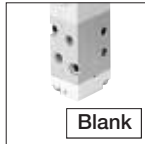

With mounting base



## Manual override

Non-locking type

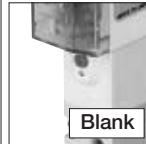

Locking type<sup>Note 2</sup>



## Sub-base

Without sub-base

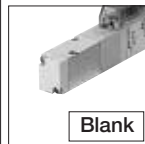

With sub-base

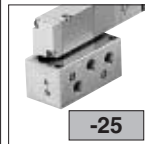

## Wiring specification

S type plug connector  
Lead wire 300mm [12in.]



L type plug connector  
Lead wire 300mm [12in.]

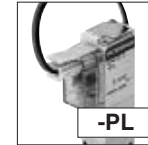

S type plug connector  
Lead wire 1000mm [39in.]



L type plug connector  
Lead wire 1000mm [39in.]

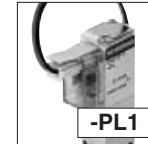

S type plug connector  
Lead wire 3000mm [118in.]



L type plug connector  
Lead wire 3000mm [118in.]

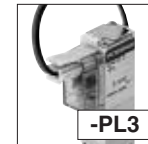

S type plug connector  
Without connector



L type plug connector  
Without connector



Grommet type<sup>Note 3</sup>  
Lead wire 300mm [12in.]  
(moisture-proof specification)



## Voltage

**-D4**

24VDC

**-D5**

12VDC<sup>Note 4</sup>

**-D6**

6VDC<sup>Note 4</sup>

**-D7**

5VDC<sup>Note 4</sup>

	Model	Valve specification	Mounting base	Sub-base	Manual override	Wiring specification	Voltage
Direct piping	HEA10 HEA10L HEA10S	F1 <sup>Note 1</sup> F2 <sup>Note 1</sup> F3 <sup>Note 1</sup> F4 <sup>Note 1</sup> F5 F6	Blank -21		Blank -81 <sup>Note 2</sup>	-PS -PS1 -PS3 -PSN -PL -PL1 -PL3 -PLN -GL <sup>Note 3</sup>	-D4 -D5 <sup>Note 4</sup> -D6 <sup>Note 4</sup> -D7 <sup>Note 4</sup>
Base piping	HEA10 HEA10L HEA10S	A1 <sup>Note 1</sup> A2 <sup>Note 1</sup> A3 <sup>Note 1</sup> A4 <sup>Note 1</sup> A5 A6		Blank -25	Blank -81 <sup>Note 2</sup>	-PS -PS1 -PS3 -PSN -PL -PL1 -PL3 -PLN -GL <sup>Note 3</sup>	-D4 -D5 <sup>Note 4</sup> -D6 <sup>Note 4</sup> -D7 <sup>Note 4</sup>

Notes: 1. Valves with valve specifications **F1, F2, F3, F4, A1, A2, A3, and A4** are for mounting on manifolds only, and cannot be used as a single valve unit.

2. The locking-type manual override is not available for the quick response type **HEA10S**.

3. The grommet type is not available for the low current type **HEA10L** and quick response type **HEA10S**.

4. The 5VDC, 6VDC and 12VDC specifications are not available for the low current type **HEA10L** and quick response type **HEA10S**.

# HEA Series Manifold Order Code

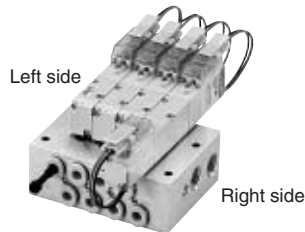
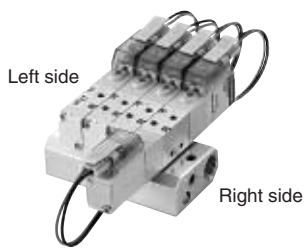

### Manifold specification

F type (direct piping type)

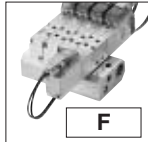

A type (base piping type)

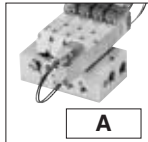

AJ type (with quick fitting)  
(base piping type)

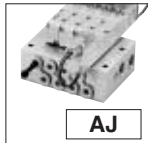

### Model

**HEA10**  
Standard type

**HEA10L**  
Low current type

**HEA10S**  
Quick response type

### Valve specification

**F1, A1:** 2-port normally closed(NC)

**F2, A2:** 2-port normally open(NO)

**F3, A3:** 3-port normally closed(NC)

**F4, A4:** 3-port normally open(NO)

**F5, A5:** 5-port 2-position, single

**F6, A6:** 5-port 2-position, double

### Manual override

Non-locking type

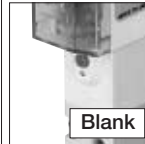

Locking type<sup>Note 2</sup>



### Wiring specification

S type plug connector  
Lead wire 300mm [12in.]

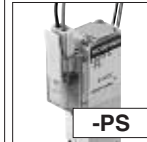

L type plug connector  
Lead wire 300mm [12in.]

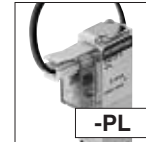

S type plug connector  
Lead wire 1000mm [39in.]



L type plug connector  
Lead wire 1000mm [39in.]



S type plug connector  
Lead wire 3000mm [118in.]



L type plug connector  
Lead wire 3000mm [118in.]



S type plug connector  
Without connector



L type plug connector  
Without connector



Grommet type<sup>Note 3</sup>  
Lead wire 300mm [12in.]  
(moisture-proof specification)



### Voltage

**-D4**  
24VDC

**-D5**  
12VDC<sup>Note 4</sup>

**-D6**  
6VDC<sup>Note 4</sup>

**-D7**  
5VDC<sup>Note 4</sup>

Model	Number of units	Manifold Specification	Station	Model	Valve specification	Manual override	Wiring specification	Voltage
Manifold code			Mounting valve code					

F type manifold (direct piping type)	HEAM	2 . . . 20	F	stn.1 . . . stn.□ Note 1	HEA10 HEA10L HEA10S	F1 F2 F3 F4 F5 F6	Blank -81 <sup>Note 2</sup>	-PS -PS1 -PS3 -PSN -PL -PL1 -PL3 -PLN -GL <sup>Note 3</sup>	-D4 -D5 <sup>Note 4</sup> -D6 <sup>Note 4</sup> -D7 <sup>Note 4</sup>
				HEABP-F (for block-off plate)					
A, AJ type manifold (base piping type)	HEAM	2 . . . 20	A AJ	stn.1 . . . stn.□ Note 1	HEA10 HEA10L HEA10S	A1 A2 A3 A4 A5 A6	Blank -81 <sup>Note 2</sup>	-PS -PS1 -PS3 -PSN -PL -PL1 -PL3 -PLN -GL <sup>Note 3</sup>	-D4 -D5 <sup>Note 4</sup> -D6 <sup>Note 4</sup> -D7 <sup>Note 4</sup>
HEABP-A (for block-off plate)									

Notes: 1. Valve mounting location is from the left side of manifold.

2. The locking-type manual override is not available for the quick response type **HEA10S**.

3. The grommet type is not available for the low current type **HEA10L** and quick response type **HEA10S**.

4. The 5VDC, 6VDC and 12VDC specifications are not available for the low current type **HEA10L** and quick response type **HEA10S**.

## HEA Series Additional Parts Order Code

---

**Block-off plate** (block-off plate, gasket, and 2 mounting screws)

**HEABP** -

**Specification**

**F** : For F type manifold

**A** : For A, AJ type manifold

**Connector-related**

**HEAZ** -

**Connector specification**

**P** : Connector, lead wire length 300mm [12in.]

**P1** : Connector, lead wire length 1000mm [39in.]

**P3** : Connector, lead wire length 3000mm [118in.]

**PN** : Connector, without lead wire (contacts included)

**Muffler** mm [in.]

**HKM-03** For in line valve

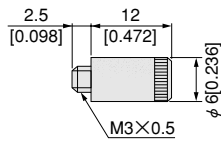

**HKM-05** For valve, sub-base and manifold

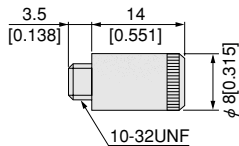

# HEA Series Dimensions of Single Valve Unit mm [in.]

## 5-port single solenoid HEA10□F5-PL

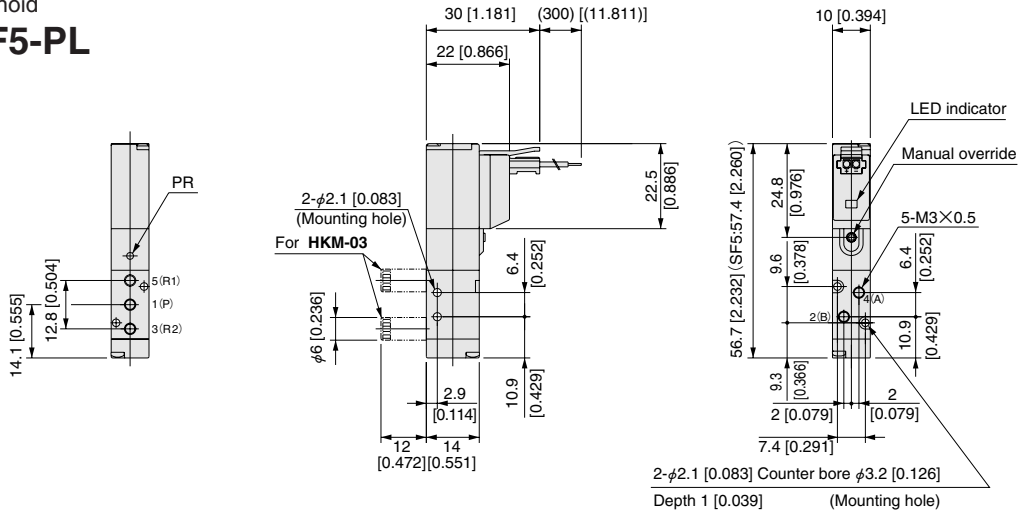

## 5-port single solenoid (with sub-base) HEA10□A5-25-PL

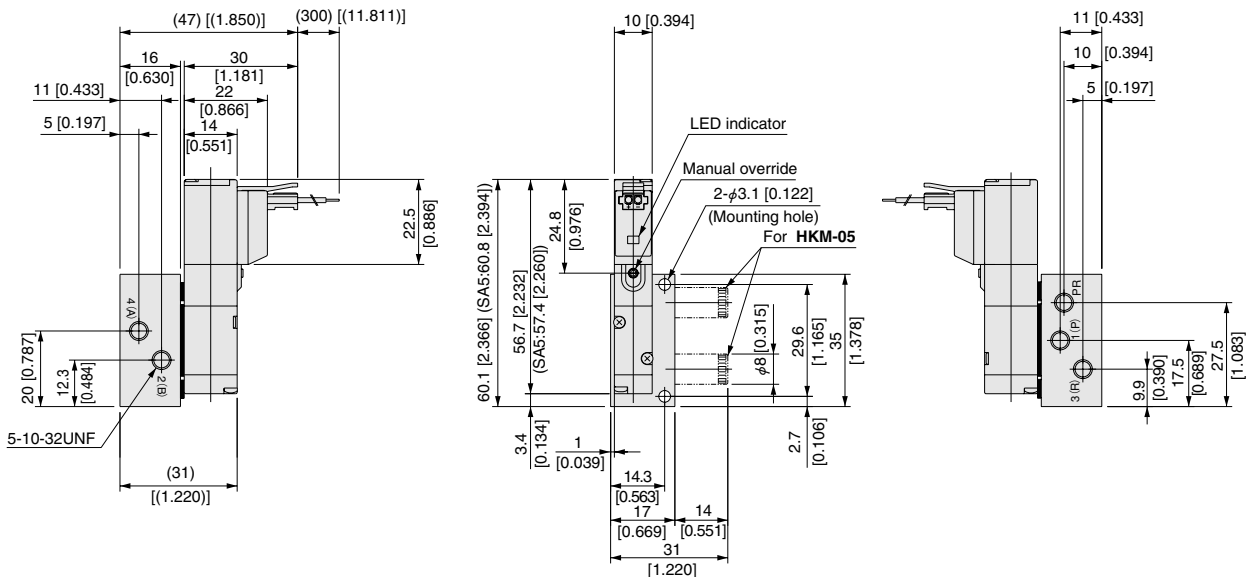

## Options

- Mounting base: **-21**
- Locking type manual override: **-81**
- Grommet: **-GL**
- S type plug connector: **-PS**

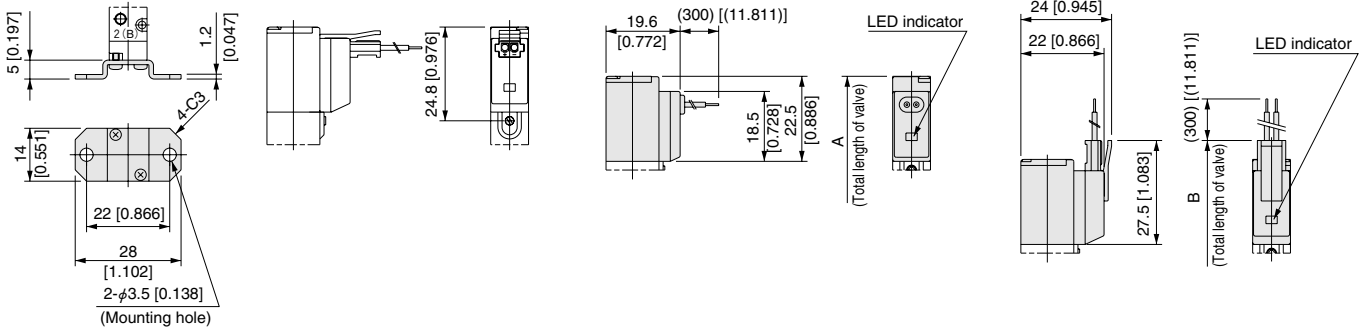

mm [in.]

Model	Code	A	B	Remark
HEA10F1 ~ HEA10F5, HEA10A1 ~ HEA10A5		56.7 [2.232]	61.7 [2.429]	Length to the end of the valve
HEA10LF1 ~ HEA10LF5, HEA10LA1 ~ HEA10LA5		—	61.7 [2.429]	
HEA10SF1 ~ HEA10SF5, HEA10SA1 ~ HEA10SA5		—	62.4 [2.457]	

# HEA Series Dimensions of Single Valve Unit mm [in.]

## 5-port double solenoid HEA10 □ F6-PL

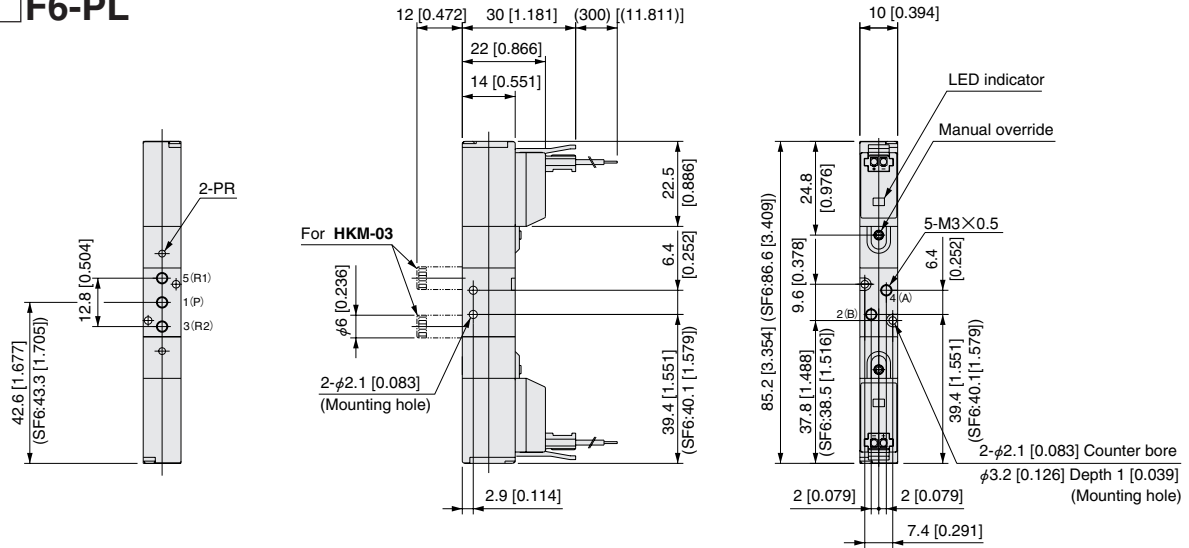

## 5-port double solenoid (with sub-base) HEA10 □ A6-25-PL

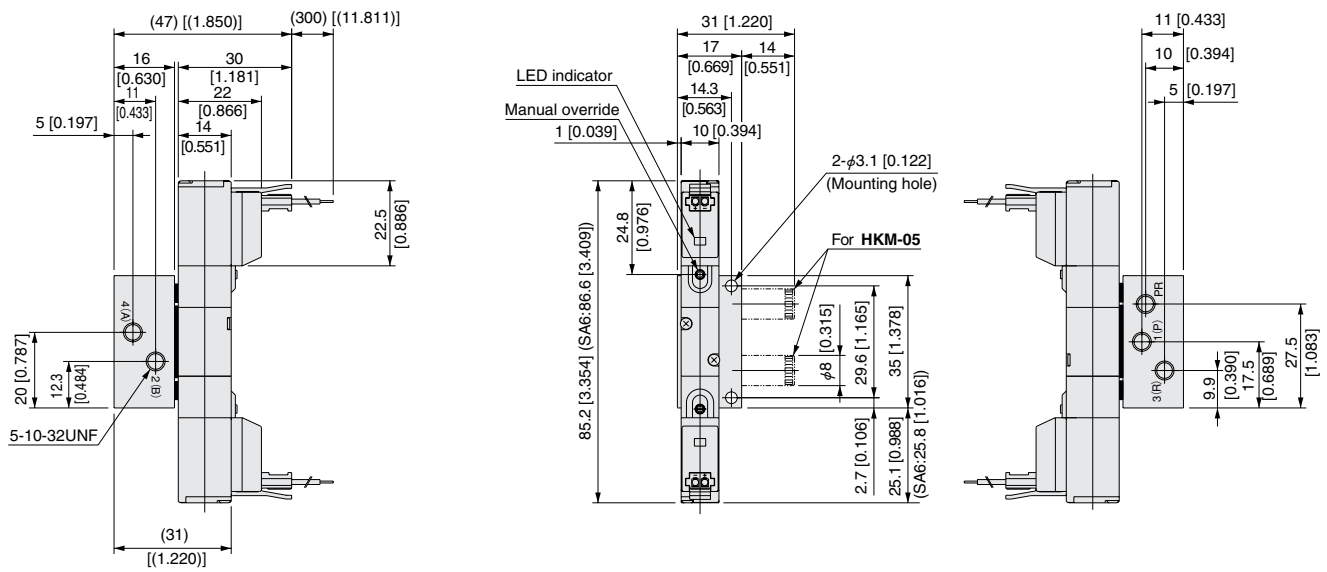

## Options

● Locking type manual override: **-81**

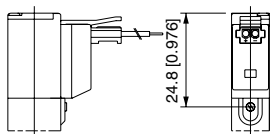

● Grommet: **-GL**

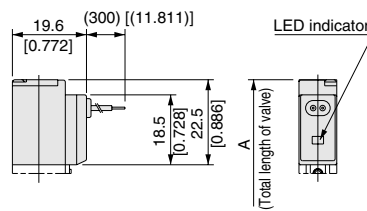

● S type plug connector: **-PS**

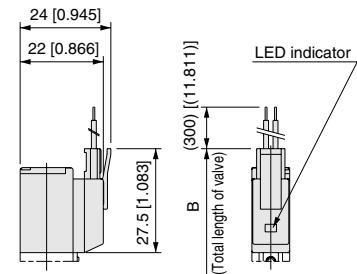

Model	Code	A	B	Remark
HEA10F6, HEA10A6		85.2 [3.354]	95.2 [3.748]	
HEA10LF6, HEA10LA6		—	95.2 [3.748]	Length to the end of solenoid on opposite side
HEA10SF6, HEA10SA6		—	96.6 [3.803]	

# HEA Series Dimensions of Manifold mm [in.]

## Manifold with combined mounting of 2, 3, 5-port valves

### HEAM F

(Direct piping type)

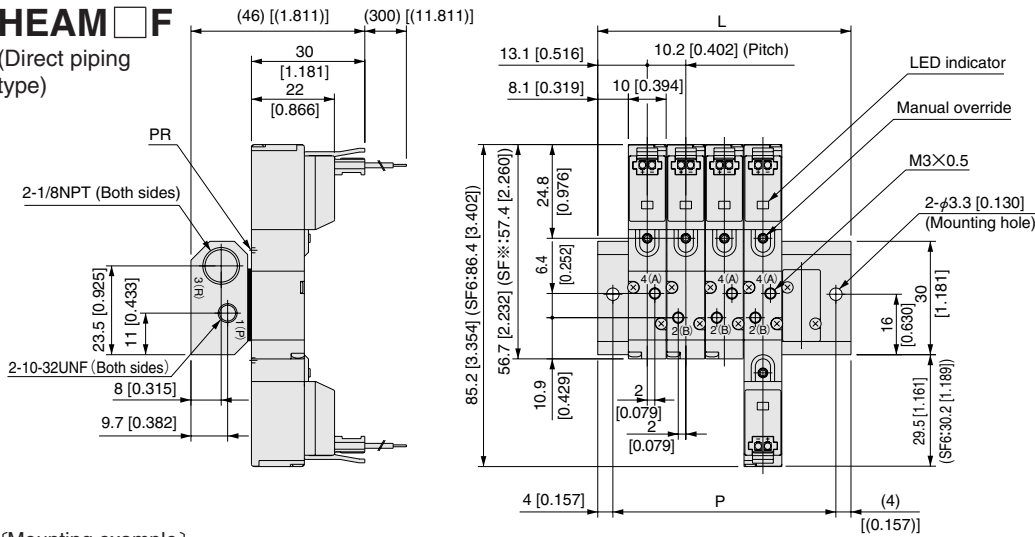

[Mounting example]

### HEAM5F

- stn.1 HEA10F3-PL-D4
- stn.2 HEA10F4-PL-D4
- stn.3 HEA10F5-PL-D4
- stn.4 HEA10F6-PL-D4
- stn.5 HEABP-F

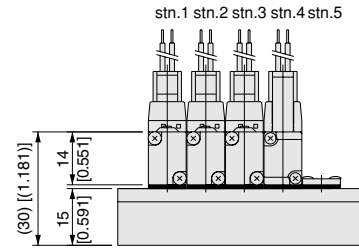

### Unit dimensions

Number of units	L	P
2	36.4 [1.433]	28.4 [1.118]
3	46.6 [1.835]	38.6 [1.520]
4	56.8 [2.236]	48.8 [1.921]
5	67.0 [2.638]	59.0 [2.323]
6	77.2 [3.039]	69.2 [2.724]
7	87.4 [3.441]	79.4 [3.126]
8	97.6 [3.843]	89.6 [3.528]
9	107.8 [4.244]	99.8 [3.929]
10	118.0 [4.646]	110.0 [4.331]
11	128.2 [5.047]	120.2 [4.732]
12	138.4 [5.449]	130.4 [5.134]
13	148.6 [5.850]	140.6 [5.535]
14	158.8 [6.252]	150.8 [5.937]
15	169.0 [6.654]	161.0 [6.339]
16	179.2 [7.055]	171.2 [6.740]
17	189.4 [7.457]	181.4 [7.142]
18	199.6 [7.858]	191.6 [7.543]
19	209.8 [8.260]	201.8 [7.945]
20	220.0 [8.661]	212.0 [8.346]

### HEAM A

(Base piping type)

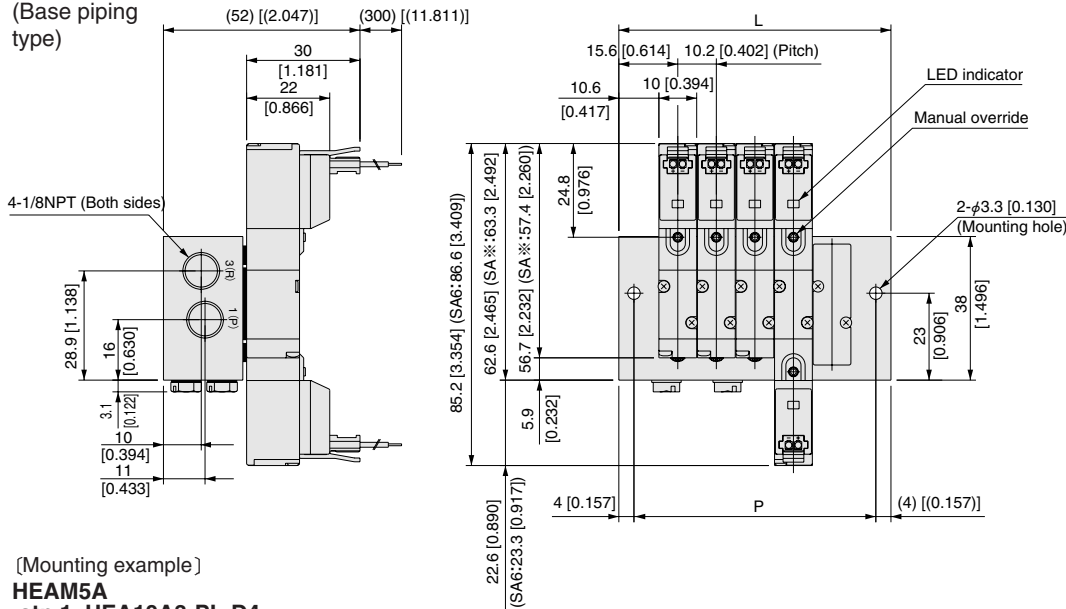

[Mounting example]

### HEAM5A

- stn.1 HEA10A3-PL-D4
- stn.2 HEA10A4-PL-D4
- stn.3 HEA10A5-PL-D4
- stn.4 HEA10A6-PL-D4
- stn.5 HEABP-A

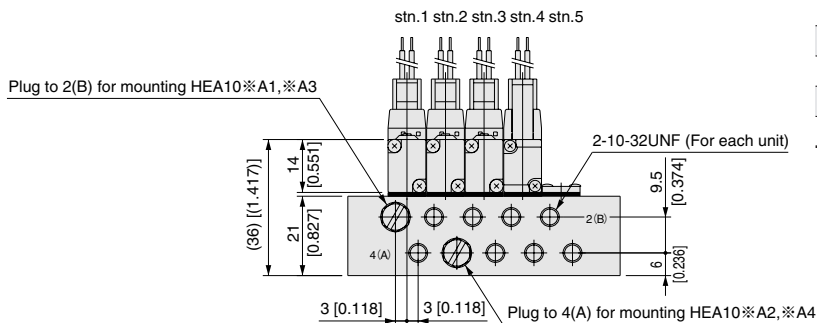

### Unit dimensions

Number of units	L	P
2	41.4 [1.630]	33.4 [1.315]
3	51.6 [2.031]	43.6 [1.717]
4	61.8 [2.433]	53.8 [2.118]
5	72.0 [2.835]	64.0 [2.520]
6	82.2 [3.236]	74.2 [2.921]
7	92.4 [3.638]	84.4 [3.323]
8	102.6 [4.039]	94.6 [3.724]
9	112.8 [4.441]	104.8 [4.126]
10	123.0 [4.843]	115.0 [4.528]
11	133.2 [5.244]	125.2 [4.929]
12	143.4 [5.646]	135.4 [5.331]
13	153.6 [6.047]	145.6 [5.732]
14	163.8 [6.449]	155.8 [6.134]
15	174.0 [6.850]	166.0 [6.535]
16	184.2 [7.252]	176.2 [6.937]
17	194.4 [7.654]	186.4 [7.339]
18	204.6 [8.055]	196.6 [7.740]
19	214.8 [8.457]	206.8 [8.142]
20	225.0 [8.858]	217.0 [8.543]

# HEA Series Dimensions of Manifold mm [in.]

Manifold with combined mounting of 2, 3, 5-port valves

## HEAM AJ

(Base piping type with quick fitting)

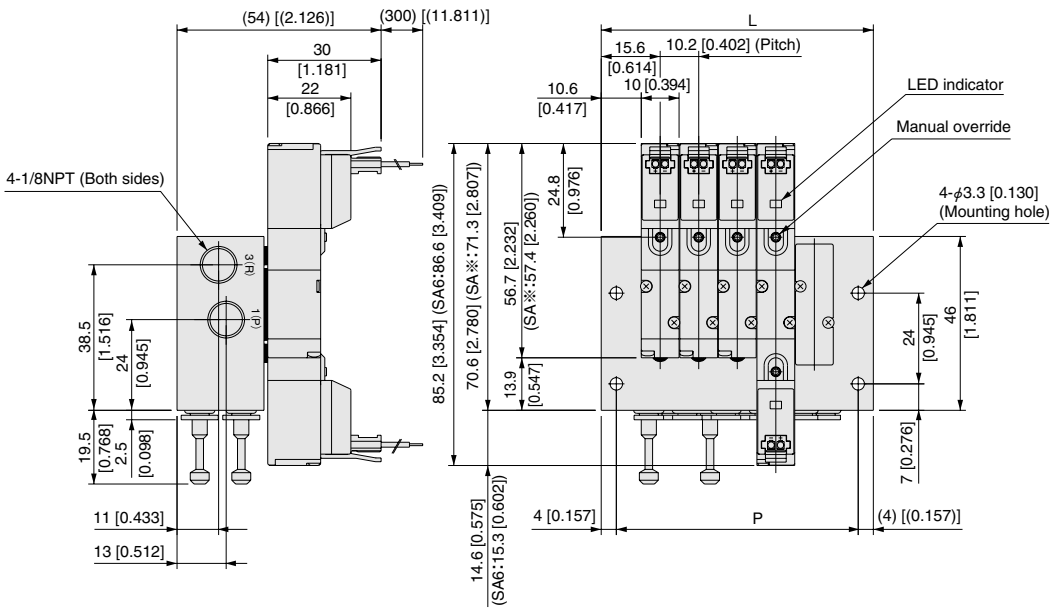

### Unit dimensions

Number of units	L	P
2	41.4 [1.630]	33.4 [1.315]
3	51.6 [2.031]	43.6 [1.717]
4	61.8 [2.433]	53.8 [2.118]
5	72.0 [2.835]	64.0 [2.520]
6	82.2 [3.236]	74.2 [2.921]
7	92.4 [3.638]	84.4 [3.323]
8	102.6 [4.039]	94.6 [3.724]
9	112.8 [4.441]	104.8 [4.126]
10	123.0 [4.843]	115.0 [4.528]
11	133.2 [5.244]	125.2 [4.929]
12	143.4 [5.646]	135.4 [5.331]
13	153.6 [6.047]	145.6 [5.732]
14	163.8 [6.449]	155.8 [6.134]
15	174.0 [6.850]	166.0 [6.535]
16	184.2 [7.252]	176.2 [6.937]
17	194.4 [7.654]	186.4 [7.339]
18	204.6 [8.055]	196.6 [7.740]
19	214.8 [8.457]	206.8 [8.142]
20	225.0 [8.858]	217.0 [8.543]

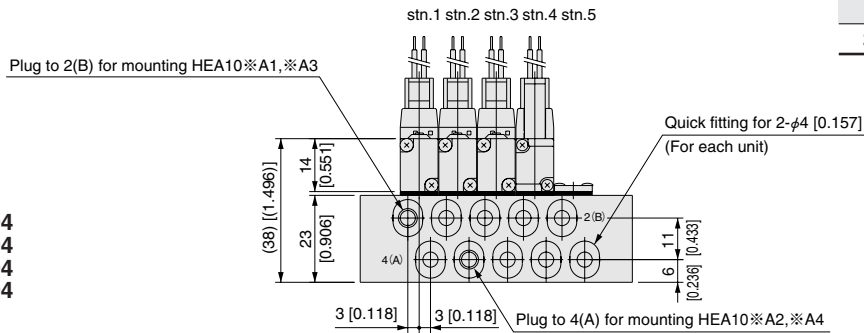

(Mounting example )

- HEAM5AJ**  
 stn.1 HEA10A3-PL-D4  
 stn.2 HEA10A4-PL-D4  
 stn.3 HEA10A5-PL-D4  
 stn.4 HEA10A6-PL-D4  
 stn.5 HEABP-A



# HEB Series Solenoid Valves

# HEB

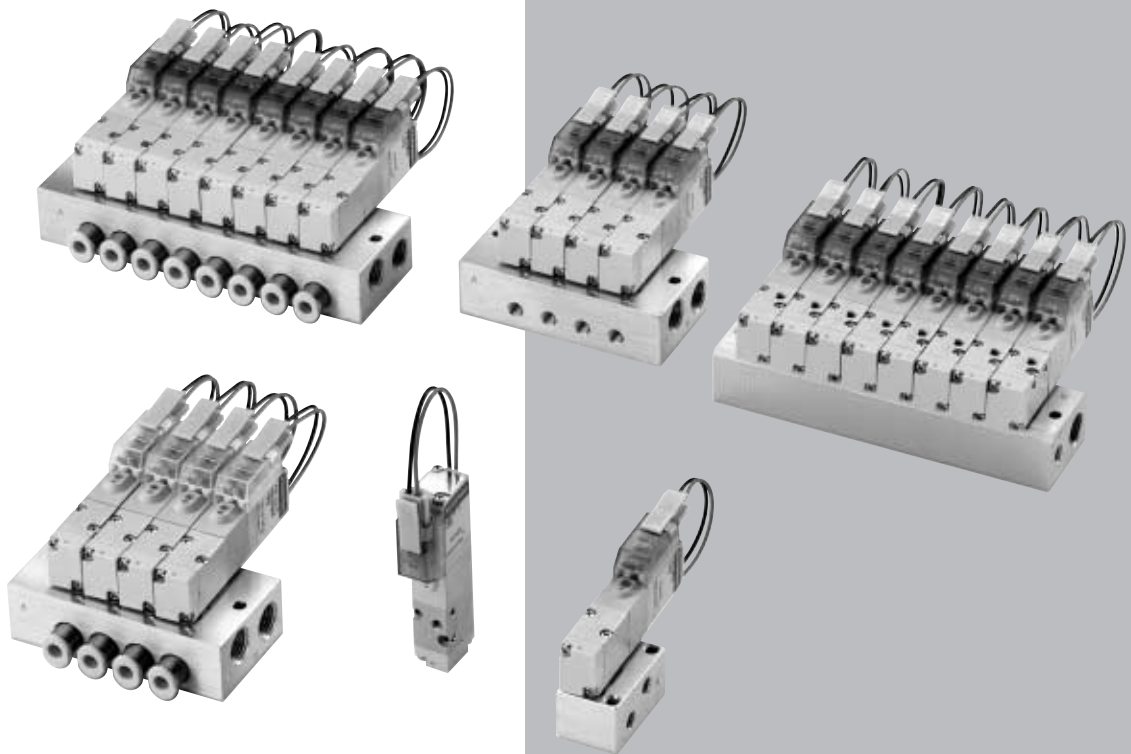

# HEB SERIES SPECIFICATIONS

## Specifications

### Basic Models and Functions

Item	Basic model	For direct piping and F type manifold	HEB10□F1 HEB10□F2 HEB10□F3 HEB10□F4
		For base piping and A, AJ type manifold	HEB10□A1 HEB10□A2 HEB10□A3 HEB10□A4
Number of positions		2 positions	
Number of ports		2, 3 ports	
Valve function		Single solenoid NC, NO	

Remark: For the optional specifications and order code, see p.29.

### Specifications

Item	Basic model	For direct piping and F type manifold	HEB10□F1 HEB10□F2 HEB10□F3 HEB10□F4
		For base piping and A, AJ type manifold	HEB10□A1 HEB10□A2 HEB10□A3 HEB10□A4
Media		Air	
Operation method		Internal pilot type	
Flow rate characteristics <sup>Note 1</sup>	Sonic conductance C	dm <sup>3</sup> /(s · bar)	Base piping (A, AJ type): 0.26
	Effective area S	mm <sup>2</sup> [Cv]	Direct piping (F type): 1.3 [0.07]
Port size <sup>Note 2</sup>		M3×0.5	
Lubrication		Not required	
Operating pressure range		MPa {kgf/cm <sup>2</sup> }	0.2~0.7 {2~7.1} [29~102psi.]
Proof pressure		MPa {kgf/cm <sup>2</sup> }	1.05 {10.7} [152psi.]
Response time <sup>Note 3</sup> ON/OFF	Standard type		Max. 10/20
	Low current type (L)		Max. 10/50
	Quick response type (S)		Max. 6/7
Maximum operating frequency Hz	Standard type		5
	Low current type (L)		2
	Quick response type (S)		10
Operating temperature range (atmosphere and media)		°C [°F]	5~50 [41~122]
Shock resistance		m/s <sup>2</sup> {G}	1373.0 {140} (Axial direction 294.2 {30})
Mounting direction		Any	

Notes: 1. For details, see the flow rate characteristics on p.26.

2. For details, see the port size on p.26.

3. Values when air pressure is 0.5MPa [73psi.].

### Solenoid Specifications

Item	Rated voltage	5VDC	6VDC	12VDC	24VDC	24VDC	24VDC	
		(Standard type)	(Standard type)	(Standard type)	(Standard type)	(Low current type)	(Quick response type)	
Operating voltage range	V	4.5~5.5 (5±10%)	5.4~6.6 (6±10%)	10.8~13.2 (12±10%)	21.6~26.4 (24±10%)	21.6~26.4 (24±10%)	21.6~26.4 (24±10%)	
Standard type	Current (When rated voltage is applied)	mA (r.m.s)	110	92	46	23	—	
	Power consumption	W	0.55	0.55	0.55	0.55	—	
Low current type Quick response type	Current (When rated voltage is applied)	Starting	—	—	—	23	125	
		Holding	—	—	—	—	6.3	46
	Power consumption	Starting	—	—	—	—	0.55	3
		Holding	—	—	—	—	0.15	1.1
	Start-up time (standard time)	ms	—	—	—	—	Max. 200	Max. 30
Allowable leakage current	mA	4.8	4	2	1	0.5	4	
Insulation resistance	MΩ	Min. 100 (value at 500VDC megger)						
Color of LED indicator		Red						
Surge suppression (as standard)		Flywheel diode						

## Port Size

Specifications	Ports	2(A)	1(P)	3(R)	PR
Single unit	Direct piping	M3×0.5	M3×0.5	M3×0.5	—
	Base piping (with sub-base)	10-32UNF	10-32UNF	10-32UNF	10-32UNF
Manifold	F type	M3×0.5	10-32UNF	1/8NPT	Assemble at 3(R) port
	A type	10-32UNF	1/8NPT	1/8NPT	
	AJ type	Quick fitting for 5/32 [0.157in.]	1/8NPT	1/8NPT	

## Flow Rate Characteristics

The test method for flow rate characteristics conforms to JIS B 8390:2000 (test method for air pressure — equipment for compressible fluids — flow rate characteristics).

### ● When using as a single unit

Basic model		Flow channel	Sonic conductance C [dm <sup>3</sup> /(s·bar)]	Critical pressure ratio b	Effective area S [mm <sup>2</sup> ] [Cv]	
Direct piping	HEB10□F1 HEB10□F2	1 (P) → 2 (A)	—	—	1.30 [0.07]	0.75 [0.04] <sup>Note 1</sup> (with fitting)
	HEB10□F3 HEB10□F4	2 (A) → 3 (R)	—	—		
Base piping (with sub-base)	HEB10□A1	1 (P) → 2 (A)	0.23	0.05	1.15 [0.06] <sup>Note 3</sup>	
	HEB10□A2	2 (A) → 3 (R)	0.23	0.38	1.15 [0.06] <sup>Note 3</sup>	
	HEB10□A3 HEB10□A4					

### ● When mounted on a manifold

Basic model		Flow channel	Sonic conductance C [dm <sup>3</sup> /(s·bar)]	Critical pressure ratio b	Effective area S [mm <sup>2</sup> ] [Cv]	
F type manifold (direct piping type)	HEB10□F1 HEB10□F2	1 (P) → 2 (A)	—	—	1.30 [0.07]	0.80 [0.05] <sup>Note 2</sup> (with fitting)
	HEB10□F3 HEB10□F4	2 (A) → 3 (R)	—	—		
A, AJ type manifold (base piping type)	HEB10□A1	1 (P) → 2 (A)	0.26	0.21	1.30 [0.07] <sup>Note 3</sup>	
	HEB10□A2	2 (A) → 3 (R)	0.24	0.46	1.20 [0.07] <sup>Note 3</sup>	
	HEB10□A3 HEB10□A4					

Notes: 1. Quick fitting TS3-M3M has been mounted on connection ports 1(P), and 2(A).

2. Quick fitting TS3-M3M has been mounted on connection port 2(A).

3. Figures in effective area S calculated based on sonic conductance C ( $S=5.0 \times C$ )

**Base piping type**  
(Effective area S = 1.3mm<sup>2</sup> [Cv: 0.07])

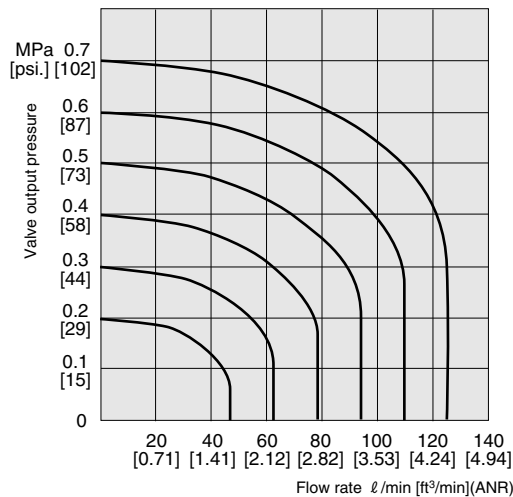

**Direct piping type with fitting**  
(Effective area S = 0.75mm<sup>2</sup> [Cv: 0.04])

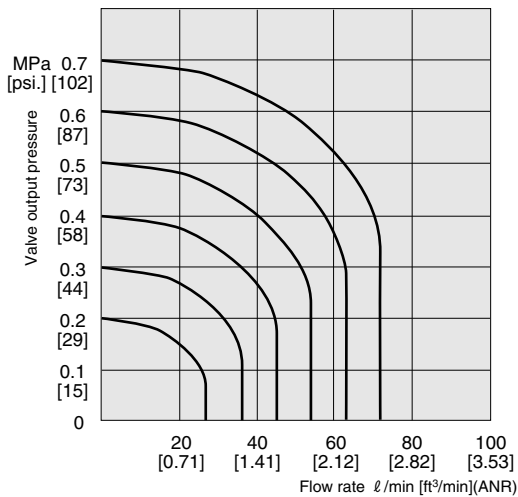

- Graphs use flow rate calculations based on the radiation method.
- Treat the flow rate as a general standard.

## Mass

### Single Valve Unit Mass

g [oz]

Basic model	Mass	Additional mass	
		-21 (with bottom mounting base)	-25 (with sub-base)
HEB10□F1	22 [0.77]	4 [0.14]	—
HEB10□F2	22 [0.77]		
HEB10□F3	22 [0.77]		
HEB10□F4	22 [0.77]		
HEB10□A1	22 [0.77]	—	17 [0.60]
HEB10□A2	22 [0.77]		
HEB10□A3	22 [0.77]		
HEB10□A4	22 [0.77]		

### Manifold Mass

g [oz]

Basic model	Mass calculation of each unit (n=number of units)	Block-off plate
HEBM□F	$(10.5 [0.37] \times n) + 15 [0.53]$	2 [0.07]
HEBM□A	$(12.5 [0.44] \times n) + 19 [0.67]$	3 [0.11]
HEBM□AJ	$(14 [0.49] \times n) + 24 [0.84]$	3 [0.11]

Calculation example: **HEBM8AJ**

**stn.1 ~ 8 HEB10A3-PS-D4**

$$(14 \times 8) + 24 + (22 \times 8) = 312\text{g}$$

$$[(0.49 \times 8) + 0.84 + (0.77 \times 8)] = 10.92\text{oz}$$

## 2-port

Normally closed (NC)

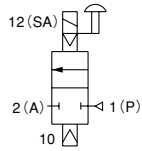

Normally open (NO)

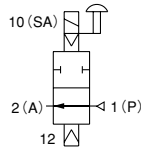

**HEB10F1**

De-energized

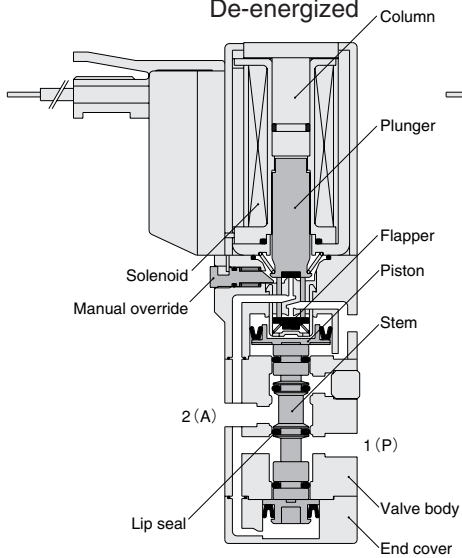

**HEB10F2**

De-energized

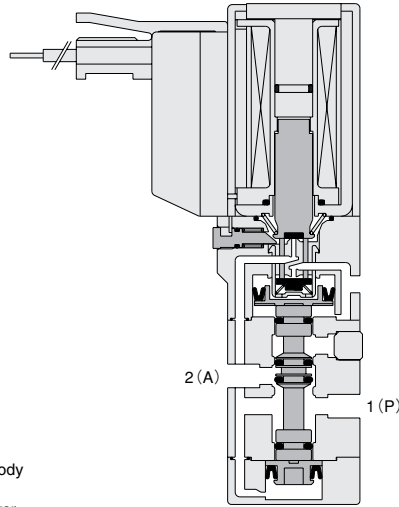

## Major Parts and Materials

Parts	Materials
Body	Aluminum alloy
Stem	(anodized)
Lip seal	Synthetic rubber
Flapper	
Valve	Mounting base
	Steel (zinc plated)
	Sub-base
	Aluminum alloy (anodized)
	Plunger
	Magnetic stainless
	Column
	End cover
	Plastic
Manifold	Body
	Aluminum alloy (anodized)
	Block-off plate
	Steel (nickel plated)
	Seal
	Synthetic rubber

## 3-port

Normally closed (NC)

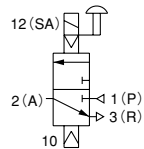

**HEB10F3**

De-energized

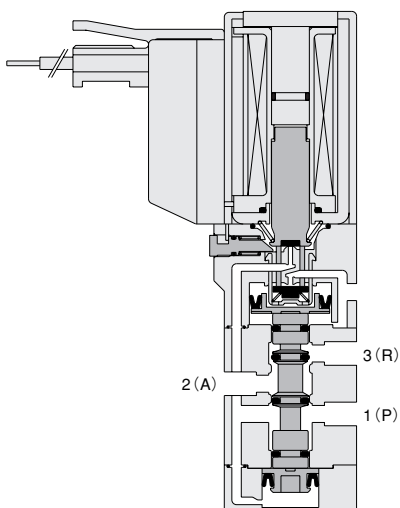

Normally open (NO)

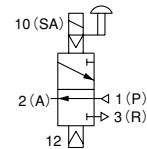

**HEB10F4**

De-energized

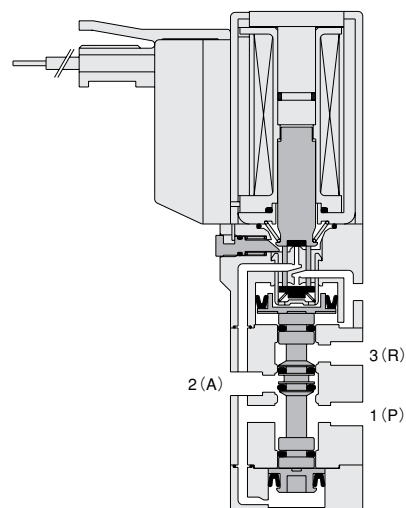

# HEB Series Single Valve Unit Order Code



## Model

**HEB10**

Standard type

**HEB10L**

Low current type

**HEB10S**

Quick response type

## Valve specification

**F1, A1:** 2-port normally closed (NC)

**F2, A2:** 2-port normally open (NO)

**F3, A3:** 3-port normally closed (NC)

**F4, A4:** 3-port normally open (NO)

## Mounting base

Without mounting base



With mounting base

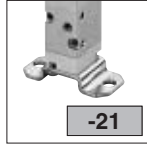

## Sub-base

Without sub-base

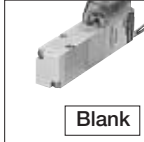

With sub-base

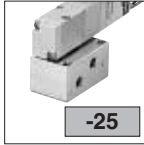

## Manual override

Non-locking type

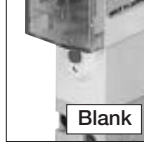

Locking type<sup>Note 1</sup>



## Wiring specification

S type plug connector  
Lead wire 300mm [12in.]



L type plug connector  
Lead wire 300mm [12in.]



S type plug connector  
Lead wire 1000mm [39in.]



L type plug connector  
Lead wire 1000mm [39in.]



S type plug connector  
Lead wire 3000mm [118in.]



L type plug connector  
Lead wire 3000mm [118in.]



S type plug connector  
Without connector



L type plug connector  
Without connector



Grommet type<sup>Note 2</sup>  
Lead wire 300mm [12in.]  
(moisture-proof specification)

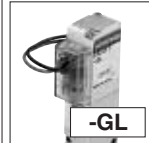

## Voltage

**-D4**

24VDC

**-D5**

12VDC<sup>Note 3</sup>

**-D6**

6VDC<sup>Note 3</sup>

**-D7**

5VDC<sup>Note 3</sup>

	Model	Valve specification	Mounting base	Sub-base	Manual override	Wiring specification	Voltage
Direct piping	HEB10 HEB10L HEB10S	F1 F2  F3 F4	Blank -21		Blank -81 <sup>Note 1</sup>	-PS -PS1 -PS3 -PSN -PL -PL1 -PL3 -PLN -GL <sup>Note 2</sup>	-D4 -D5 <sup>Note 3</sup> -D6 <sup>Note 3</sup> -D7 <sup>Note 3</sup>
Base piping	HEB10 HEB10L HEB10S	A1 A2 A3 A4		Blank -25	Blank -81 <sup>Note 1</sup>	-PS -PS1 -PS3 -PSN -PL -PL1 -PL3 -PLN -GL <sup>Note 2</sup>	-D4 -D5 <sup>Note 3</sup> -D6 <sup>Note 3</sup> -D7 <sup>Note 3</sup>

Notes: 1. The locking-type manual override is not available for the quick response type **HEB10S**.

2. The grommet type is not available for the low current type **HEB10L** and quick response type **HEB10S**.

3. The 5VDC, 6VDC and 12VDC specifications are not available for the low current type **HEB10L** and quick response type **HEB10S**.

# HEB Series Manifold Order Code

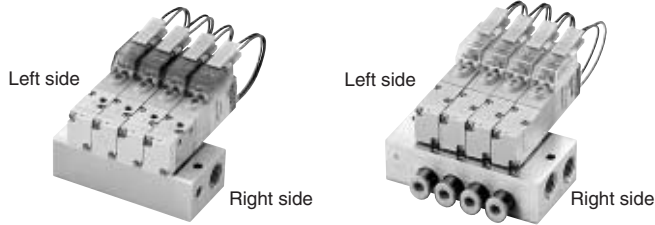

### Manifold specification

F type (direct piping type)

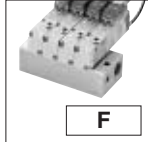

**F**

A type (base piping type)

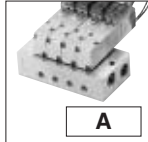

**A**

AJ type (with quick fitting)  
(base piping type)

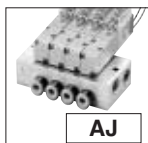

**AJ**

### Model

**HEB10**  
Standard type

**HEB10L**  
Low current type

**HEB10S**  
Quick response type

### Valve specification

**F1, A1:** 2-port normally closed(NC)

**F2, A2:** 2-port normally open(NO)

**F3, A3:** 3-port normally closed(NC)

**F4, A4:** 3-port normally open(NO)

### Manual Override

Non-locking type

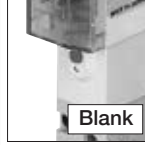

**Blank**

Locking type<sup>Note 2</sup>

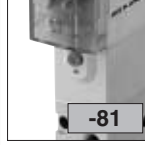

**-81**

### Wiring specification

S type plug connector

Lead wire 300mm [12in.]

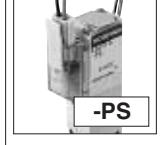

**-PS**

L type plug connector

Lead wire 300mm [12in.]



**-PL**

S type plug connector

Lead wire 1000mm [39in.]



**-PS1**

L type plug connector

Lead wire 1000mm [39in.]



**-PL1**

S type plug connector

Lead wire 3000mm [118in.]



**-PS3**

L type plug connector

Lead wire 3000mm [118in.]

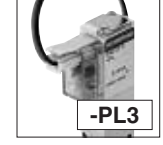

**-PL3**

S type plug connector

Without connector



**-PSN**

L type plug connector

Without connector

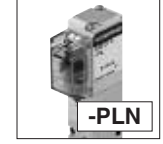

**-PLN**

Grommet type<sup>Note 3</sup>  
Lead wire 300mm [12in.]  
(moisture-proof specification)



**-GL**

### Voltage

**-D4**

24VDC

**-D5**

12VDC<sup>Note 4</sup>

**-D6**

6VDC<sup>Note 4</sup>

**-D7**

5VDC<sup>Note 4</sup>

Model	Number of units	Manifold specification	Station	Model	Valve specification	Manual override	Wiring specification	Voltage
Manifold code			Mounting valve code					

F type manifold (direct piping type)	HEBM	2 . . . 20	F	stn.1 . . . stn.□ Note 1	HEB10 HEB10L HEB10S	F1 F2 F3 F4	Blank -81 <sup>Note 2</sup>	-PS -PS1 -PS3 -PSN -PL -PL1 -PL3 -PLN -GL <sup>Note 3</sup>	-D4 -D5 <sup>Note 4</sup> -D6 <sup>Note 4</sup> -D7 <sup>Note 4</sup>
				HEBBP-F (for block-off plate)					
A, AJ type manifold (base piping type)	HEBM	2 . . . 20	A AJ	stn.1 . . . stn.□ Note 1	HEB10 HEB10L HEB10S	A1 A2 A3 A4	Blank -81 <sup>Note 2</sup>	-PS -PS1 -PS3 -PSN -PL -PL1 -PL3 -PLN -GL <sup>Note 3</sup>	-D4 -D5 <sup>Note 4</sup> -D6 <sup>Note 4</sup> -D7 <sup>Note 4</sup>
HEBBP-A (for block-off plate)									

Notes: 1. Valve mounting location is from the left side of manifold.

2. The locking-type manual override is not available for the quick response type HEB10S.

3. The grommet type is not available for the low current type HEB10L and quick response type HEB10S.

4. The 5VDC, 6VDC and 12VDC specifications are not available for the low current type HEB10L and quick response type HEB10S.

## HEB Series Additional Parts Order Code

**Block-off plate** (block-off plate, gasket, and 2 mounting screws)

**HEBBP** -

**Specification**

**F** : For F type manifold

**A** : For A, AJ type manifold

**Connector-related**

**HEAZ** -

**Connector specification**

**P** : Connector, lead wire length 300mm [12in.]

**P1** : Connector, lead wire length 1000mm [39in.]

**P3** : Connector, lead wire length 3000mm [118in.]

**PN** : Connector, without lead wire (contacts included)

**Muffler** mm [in.]

**HKM-03** For in line valve

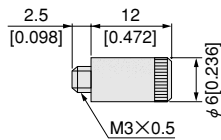

**HKM-05** For valve, sub-base and manifold

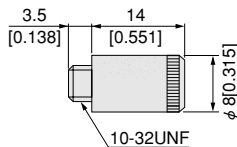



# HEB Series Dimensions of Single Valve Unit mm [in.]

2, 3-port single solenoid  
**HEB10□F1-PL**  
**HEB10□F2-PL**  
**HEB10□F3-PL**  
**HEB10□F4-PL**

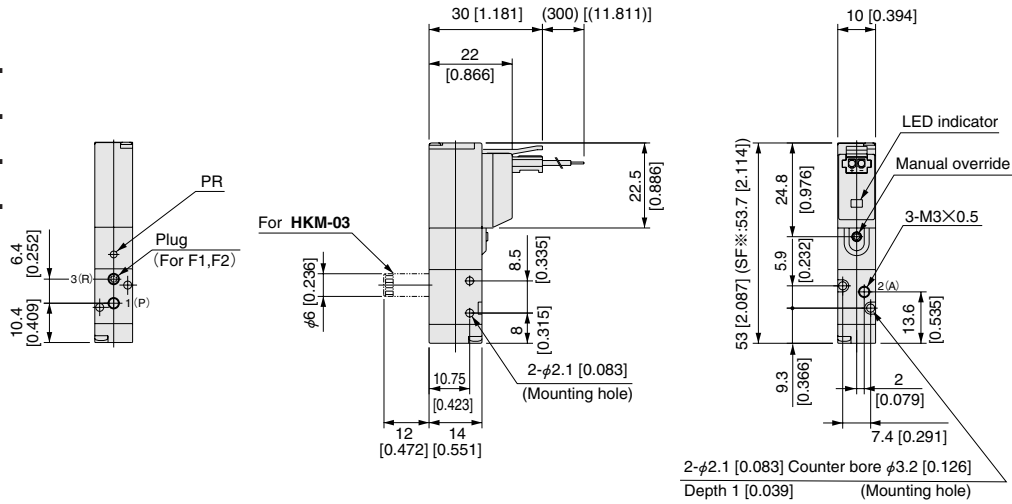

2, 3-port single solenoid (with sub-base)  
**HEB10□A1-25-PL**  
**HEB10□A2-25-PL**  
**HEB10□A3-25-PL**  
**HEB10□A4-25-PL**

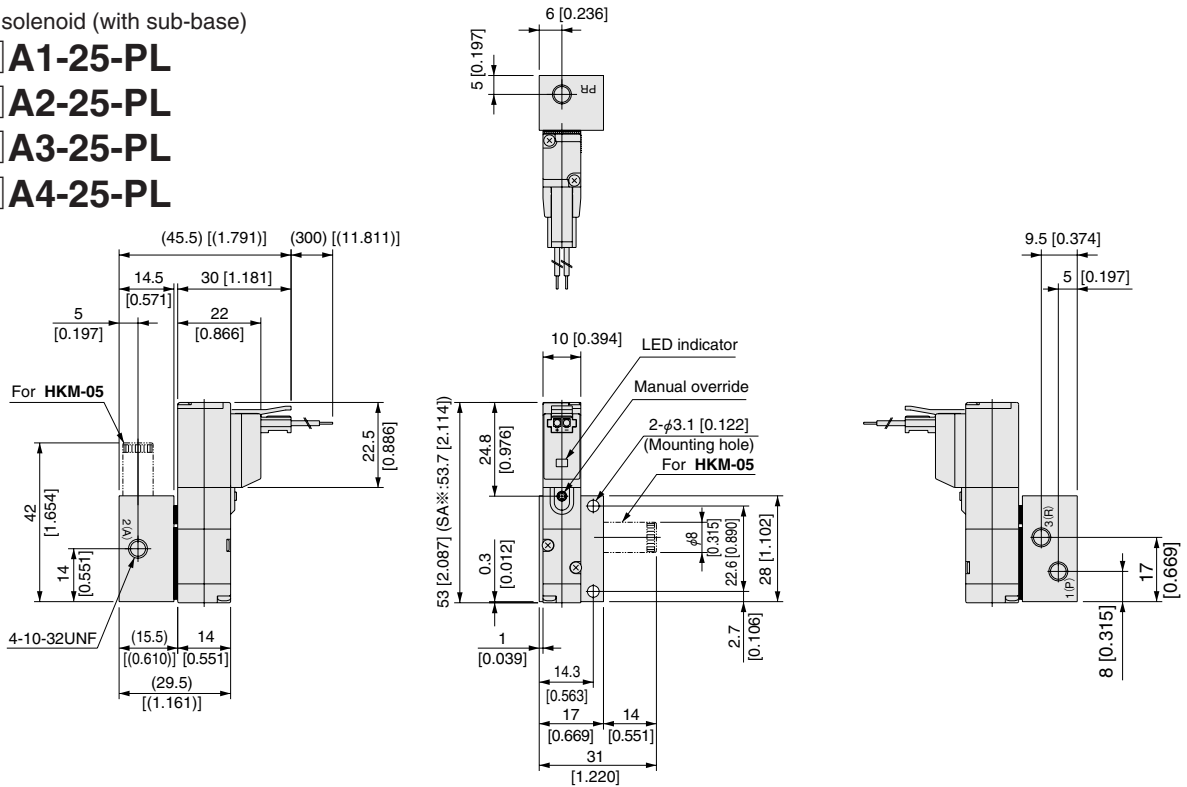

## Options

- Mounting base: **-21**
- Locking type manual override: **-81**
- Grommet: **-GL**
- S type plug connector: **-PS**

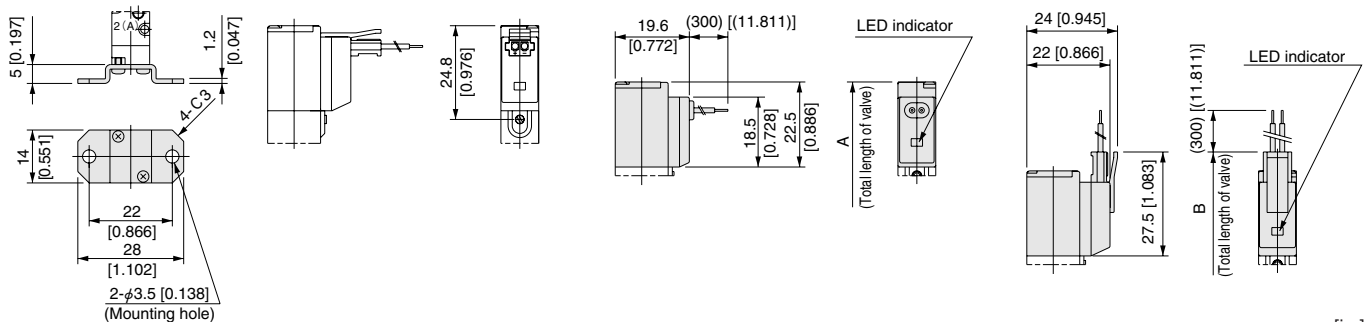

Model	Code	A	B	Remark
HEB10F1 ~ HEB10F4, HEB10A1 ~ HEB10A4		53 [2.087]	58 [2.283]	
HEB10LF1 ~ HEB10LF4, HEB10LA1 ~ HEB10LA4		—	58 [2.283]	Length to the end of the valve
HEB10SF1 ~ HEB10SF4, HEB10SA1 ~ HEB10SA4		—	58.7 [2.311]	

# HEB Series Dimensions of Manifold mm [in.]

For 2, 3-port  
**HEBM**  **F**  
 (Direct piping type)

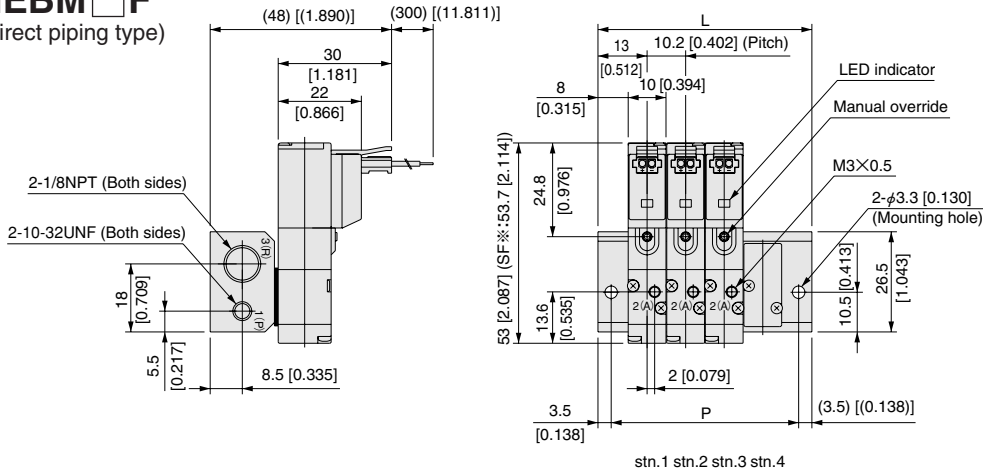

(Mounting example)  
**HEBM4F**  
 stn.1 HEB10F1-PL-D4  
 stn.2 HEB10F3-PL-D4  
 stn.3 HEB10F4-PL-D4  
 stn.4 HEBBP-F

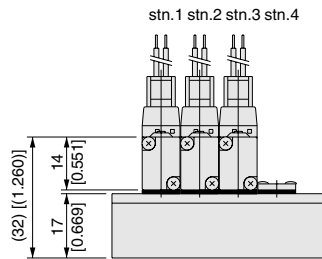

## Unit dimensions

Number of units	L	P
2	36.2 [1.425]	29.2 [1.150]
3	46.4 [1.827]	39.4 [1.551]
4	56.6 [2.228]	49.6 [1.953]
5	66.8 [2.630]	59.8 [2.354]
6	77.0 [3.031]	70.0 [2.756]
7	87.2 [3.433]	80.2 [3.157]
8	97.4 [3.835]	90.4 [3.559]
9	107.6 [4.236]	100.6 [3.961]
10	117.8 [4.638]	110.8 [4.362]
11	128.0 [5.039]	121.0 [4.764]
12	138.2 [5.441]	131.2 [5.165]
13	148.4 [5.843]	141.4 [5.567]
14	158.6 [6.244]	151.6 [5.968]
15	168.8 [6.646]	161.8 [6.370]
16	179.0 [7.047]	172.0 [6.772]
17	189.2 [7.449]	182.2 [7.173]
18	199.4 [7.850]	192.4 [7.575]
19	209.6 [8.252]	202.6 [7.976]
20	219.8 [8.654]	212.8 [8.378]

**HEBM**  **A**  
 (Base piping type)

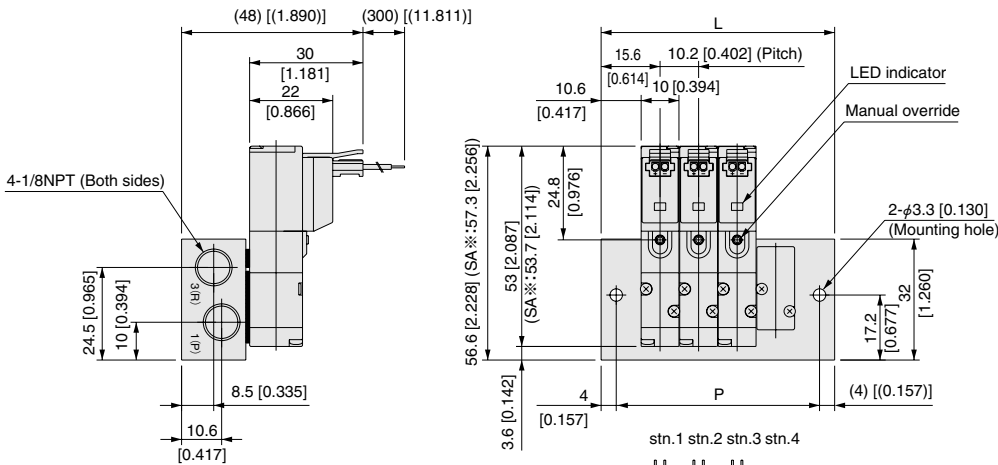

(Mounting example)  
**HEBM4A**  
 stn.1 HEB10A1-PL-D4  
 stn.2 HEB10A3-PL-D4  
 stn.3 HEB10A4-PL-D4  
 stn.4 HEBBP-A

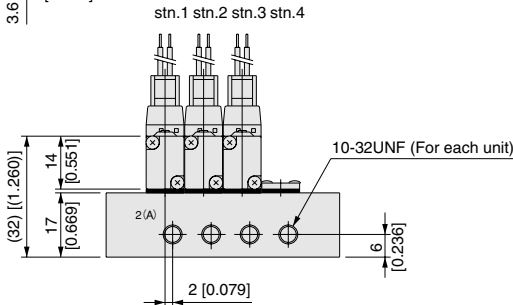

## Unit dimensions

Number of units	L	P
2	41.4 [1.630]	33.4 [1.315]
3	51.6 [2.031]	43.6 [1.717]
4	61.8 [2.433]	53.8 [2.118]
5	72.0 [2.835]	64.0 [2.520]
6	82.2 [3.236]	74.2 [2.921]
7	92.4 [3.638]	84.4 [3.323]
8	102.6 [4.039]	94.6 [3.724]
9	112.8 [4.441]	104.8 [4.126]
10	123.0 [4.843]	115.0 [4.528]
11	133.2 [5.244]	125.2 [4.929]
12	143.4 [5.646]	135.4 [5.331]
13	153.6 [6.047]	145.6 [5.732]
14	163.8 [6.449]	155.8 [6.134]
15	174.0 [6.850]	166.0 [6.535]
16	184.2 [7.252]	176.2 [6.937]
17	194.4 [7.654]	186.4 [7.339]
18	204.6 [8.055]	196.6 [7.740]
19	214.8 [8.457]	206.8 [8.142]
20	225.0 [8.858]	217.0 [8.543]

# HEB Series Dimensions of Manifold mm [in.]

For 2, 3-port

## HEBM AJ

(Base piping type with quick fitting)

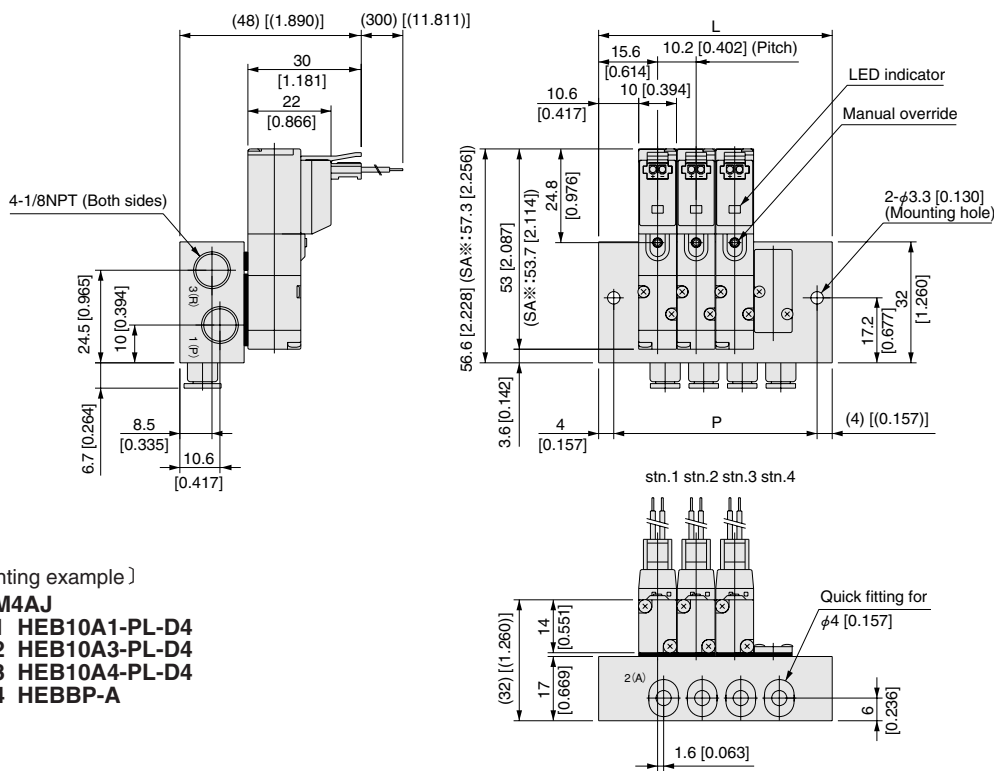

[Mounting example]

### HEBM4AJ

stn.1 HEB10A1-PL-D4

stn.2 HEB10A3-PL-D4

stn.3 HEB10A4-PL-D4

stn.4 HEBBP-A

## Unit dimensions

Number of units	L	P
2	41.4 [1.630]	33.4 [1.315]
3	51.6 [2.031]	43.6 [1.717]
4	61.8 [2.433]	53.8 [2.118]
5	72.0 [2.835]	64.0 [2.520]
6	82.2 [3.236]	74.2 [2.921]
7	92.4 [3.638]	84.4 [3.323]
8	102.6 [4.039]	94.6 [3.724]
9	112.8 [4.441]	104.8 [4.126]
10	123.0 [4.843]	115.0 [4.528]
11	133.2 [5.244]	125.2 [4.929]
12	143.4 [5.646]	135.4 [5.331]
13	153.6 [6.047]	145.6 [5.732]
14	163.8 [6.449]	155.8 [6.134]
15	174.0 [6.850]	166.0 [6.535]
16	184.2 [7.252]	176.2 [6.937]
17	194.4 [7.654]	186.4 [7.339]
18	204.6 [8.055]	196.6 [7.740]
19	214.8 [8.457]	206.8 [8.142]
20	225.0 [8.858]	217.0 [8.543]



# HJC Series Solenoid Valves

# HJC

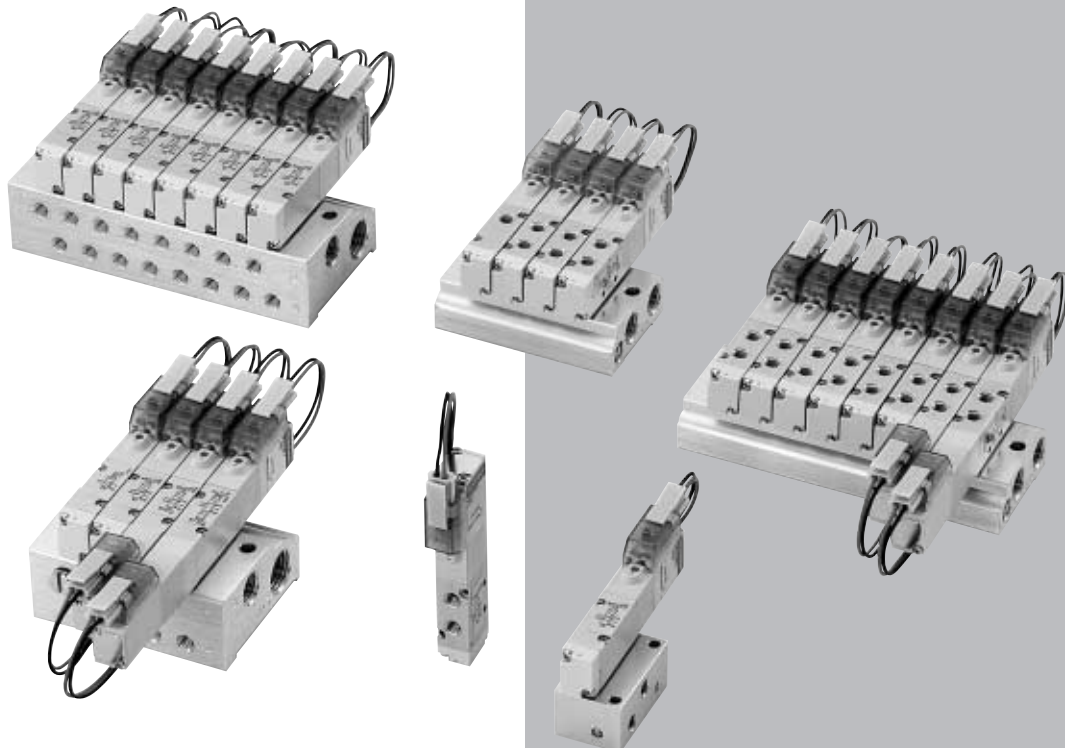

# HJC SERIES SPECIFICATIONS

## Specifications

### Basic Models and Functions

Basic model	For direct piping and F type manifold	HJC10□F1 <sup>Note</sup> HJC10□F2 <sup>Note</sup> HJC10□F3 <sup>Note</sup> HJC10□F4 <sup>Note</sup>	HJC10□F5	HJC10□F6	HJC10□F7 HJC10□F8 HJC10□F9
	For base piping and A type manifold	HJC10□A1 <sup>Note</sup> HJC10□A2 <sup>Note</sup> HJC10□A3 <sup>Note</sup> HJC10□A4 <sup>Note</sup>	HJC10□A5	HJC10□A6	HJC10□A7 HJC10□A8 HJC10□A9
Item					
Number of positions	2 positions			3 positions	
Number of ports	2, 3 ports		5 ports		
Valve function	Single solenoid NC, NO	Single solenoid	Double solenoid	Closed center, exhaust center, pressure center	

Remark: For the optional specifications and order code, see p.41.

Note: Valves with valve specifications F1, F2, F3, F4, A1, A2, A3, and A4 are for mounting on manifolds only, and cannot be used as a single valve unit.

### Specifications

Basic model	For direct piping and F type manifold	HJC10□F1 HJC10□F2 HJC10□F3 HJC10□F4	HJC10□F5	HJC10□F6	HJC10□F7 HJC10□F8 HJC10□F9
	For base piping and A type manifold	HJC10□A1 HJC10□A2 HJC10□A3 HJC10□A4	HJC10□A5	HJC10□A6	HJC10□A7 HJC10□A8 HJC10□A9
Item					
Media	Air				
Operation method	Internal pilot type				
Flow rate characteristics <sup>Note 1</sup>	0.6				
Sonic conductance C	dm <sup>3</sup> /(s · bar)				
Port size <sup>Note 2</sup>	10-32UNF				
Lubrication	Not required				
Operating pressure range	MPa {kgf/cm <sup>2</sup> }	0.2~0.7 {2~7.1} [29~102psi.]			0.25~0.7 {2.5~7.1} [36.5~102psi.]
Proof pressure	MPa {kgf/cm <sup>2</sup> }	1.05 {10.7} [152psi.]			
Response time <sup>Note 3</sup>	ms	Standard type	Max. 10/20	Max. 12	Max. 10/30
		Low current type (L)	Max. 10/50	Max. 12	Max. 10/60
		Quick response type (S)	Max. 6/7	Max. 6	Max. 6/12
Maximum operating frequency	Hz	Standard type	5		
		Low current type (L)	2		
		Quick response type (S)	10		
Minimum time to energize for self holding <sup>Note 4</sup>	ms	—	50	—	
Operating temperature range (atmosphere and media)	°C [°F]	5~50 [41~122]			
Shock resistance	m/s <sup>2</sup> {G}	1373.0 {140} (Axial direction 294.2 {30})	1373.0 {140} (Axial direction 147.1 {15})	1373.0 {140} (Axial direction 195.0 {20})	
Mounting direction		Any			

Notes: 1. For details, see the flow rate characteristics on p.38.

2. For details, see the port size on p.39.

3. Values when air pressure is 0.5MPa [73psi.]. The values for the 3-position valves are those switching from neutral state.

4. For double solenoid valve.

### Solenoid Specifications

Item	Rated voltage	5VDC	6VDC	12VDC	24VDC	24VDC	24VDC	
		(Standard type)	(Standard type)	(Standard type)	(Standard type)	(Low current type)	(Quick response type)	
Operating voltage range	V	4.5~5.5 (5±10%)	5.4~6.6 (6±10%)	10.8~13.2 (12±10%)	21.6~26.4 (24±10%)	21.6~26.4 (24±10%)	21.6~26.4 (24±10%)	
Standard type	Current (When rated voltage is applied)	110	92	46	23	—	—	
	Power consumption	0.55	0.55	0.55	0.55	—	—	
Low current type Quick response type	Current (When rated voltage is applied)	Starting	—	—	—	23	125	
		Holding	—	—	—	6.3	46	
	Power consumption	Starting	—	—	—	—	0.55	3
		Holding	—	—	—	—	0.15	1.1
	Start-up time (standard time)	ms	—	—	—	—	Max. 200	Max. 30
Allowable leakage current	mA	4.8	4	2	1	0.5	4	
Insulation resistance	MΩ	Min. 100 (value at 500VDC megger)						
Color of LED indicator		Red						
Surge suppression (as standard)		Flywheel diode						

## Flow Rate Characteristics

The test method for flow rate characteristics conforms to JIS B 8390:2000 (test method for air pressure — equipment for compressible fluids — flow rate characteristics).

### ● When using as a single unit (with fitting)

Basic model		Flow channel	Sonic conductance C [dm <sup>3</sup> /(s·bar)]	Critical pressure ratio b	Effective area S [mm <sup>2</sup> ] [Cv]	
Direct piping <sup>Note 1</sup>	HJC10□F5 HJC10□F6	1 (P) → 4 (A)	—	—	2.80 [0.16]	
		1 (P) → 2 (B)	—	—		
		4 (A) → 5 (R1)	—	—		
	HJC10□F7 HJC10□F8 HJC10□F9	2 (B) → 3 (R2)	—	—	2.50 [0.14]	
		1 (P) → 4 (A)	—	—		
		1 (P) → 2 (B)	—	—		
	Base piping <sup>Note 1</sup> (with sub-base)	HJC10□A5 HJC10□A6	4 (A) → 5 (R1)	—	—	2.90 [0.16] <sup>Note 3</sup>
			2 (B) → 3 (R2)	—	—	
			1 (P) → 4 (A)	0.58	0.40	
1 (P) → 2 (B)			0.57	0.37	2.55 [0.14] <sup>Note 3</sup>	
HJC10□A7 HJC10□A8 HJC10□A9		2 (B) → 3 (R2)	0.61	0.26	3.05 [0.17] <sup>Note 3</sup>	
		1 (P) → 4 (A)	0.52	0.36	2.60 [0.15] <sup>Note 3</sup>	
		1 (P) → 2 (B)	0.53	0.33	2.65 [0.15] <sup>Note 3</sup>	
		4 (A) → 5 (R1)	0.49	0.27	2.45 [0.14] <sup>Note 3</sup>	
		2 (B) → 3 (R2)	0.55	0.27	2.75 [0.15] <sup>Note 3</sup>	

### ● When mounted on a manifold (with fitting)

Basic model		Flow channel	Sonic conductance C [dm <sup>3</sup> /(s·bar)]	Critical pressure ratio b	Effective area S <sup>Note 3</sup> [mm <sup>2</sup> ] [Cv]		
F type manifold <sup>Note 2</sup> (direct piping type)	HJC10□F1 HJC10□F2 HJC10□F3 HJC10□F4 HJC10□F5 HJC10□F6	1 (P) → 4 (A)	0.66	0.54	3.30 [0.19]		
		1 (P) → 2 (B)	0.62	0.46	3.10 [0.17]		
		4 (A) → 5 (R1)	0.58	0.33	2.90 [0.16]		
		2 (B) → 3 (R2)	0.55	0.14	2.75 [0.15]		
		1 (P) → 4 (A)	0.56	0.41	2.80 [0.16]		
		1 (P) → 2 (B)	0.56	0.42	2.80 [0.16]		
	HJC10□F7 HJC10□F8 HJC10□F9	4 (A) → 5 (R1)	0.53	0.32	2.65 [0.15]		
		2 (B) → 3 (R2)	0.50	0.13	2.50 [0.14]		
		A type manifold <sup>Note 2</sup> (base piping type)	HJC10□A1 HJC10□A2 HJC10□A3	1 (P) → 4 (A)	0.61	0.33	3.05 [0.17]
				1 (P) → 2 (B)	0.60	0.31	3.00 [0.17]
				4 (A) → 5 (R1)	0.61	0.08	3.05 [0.17]
			HJC10□A4 HJC10□A5 HJC10□A6	2 (B) → 3 (R2)	0.60	0.08	3.00 [0.17]
HJC10□A7 HJC10□A8 HJC10□A9	1 (P) → 4 (A)			0.54	0.29	2.70 [0.15]	
	1 (P) → 2 (B)			0.54	0.30	2.70 [0.15]	
	4 (A) → 5 (R1)	0.57	0.08	2.85 [0.16]			
2 (B) → 3 (R2)	0.54	0.09	2.70 [0.15]				

Notes: 1. Quick fitting TSH6-M5M has been mounted on connection ports 1(P), 2(B), and 4(A).

2. Quick fitting TSH6-M5M has been mounted on connection ports 2(B) and 4(A).

3. Figures in effective area S calculated based on sonic conductance C ( $S=5.0 \times C$ ).

### (Effective area S=3.0mm<sup>2</sup> [Cv: 0.17])

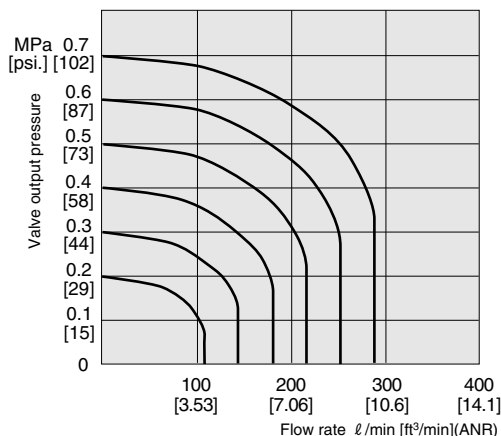

- Graphs use flow rate calculations based on the radiation method.
- Treat the flow rate as a general standard.

## Port Size

Specifications	Ports	2 (B), 4 (A)	1 (P)	3·5 (R)
Single unit	Direct piping	10-32UNF	10-32UNF	M3×0.5
	Base piping (with sub-base)	10-32UNF	10-32UNF	10-32UNF
Manifold	F type	10-32UNF	1/8NPT	1/8NPT
	A type	10-32UNF	1/8NPT	1/4NPT

## Mass

### Single Valve Unit Mass

g [oz]

Basic model	Mass	Additional mass	
		-21 (with bottom mounting base)	-25 (with sub-base)
HJC10□F1	26 [0.92]	—	—
HJC10□F2			
HJC10□F3			
HJC10□F4			
HJC10□F5	26 [0.92]	4 [0.14]	—
HJC10□F6	40 [1.41]	—	
HJC10□F7	43 [1.51]		
HJC10□F8			
HJC10□F9			
HJC10□A1	26 [0.92]	—	—
HJC10□A2			
HJC10□A3			
HJC10□A4			
HJC10□A5	26 [0.92]	—	27 [0.95]
HJC10□A6	40 [1.41]		
HJC10□A7	43 [1.51]		
HJC10□A8			
HJC10□A9			

### Manifold Mass

g [oz]

Basic model	Mass calculation of each unit (n = number of units)	Block-off plate	With DIN rail mounting bracket
HJCM□F	$(12.5 [0.44] \times n) + 20 [0.70]$	3 [0.11]	—
HJCM□A	$(22.5 [0.79] \times n) + 42 [1.48]$		15 [0.53]

Calculation example: **HJCM8A**

stn.1~8 HJC10A5-PS-D4

$$(22.5 \times 8) + 42 + (26 \times 8) = 430\text{g}$$

$$[(0.79 \times 8) + 1.48 + (0.92 \times 8)] = 15.16\text{oz}$$



## 5-port, 2-position

### Single solenoid

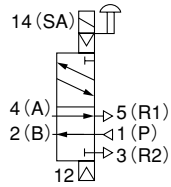

### HJC10F5 De-energized

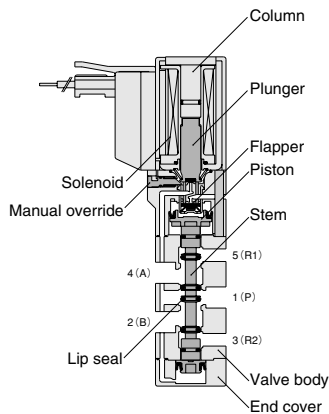

### Double solenoid

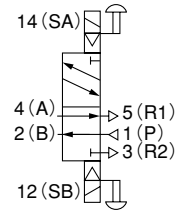

### HJC10F6 [De-energized condition after energizing solenoid 12 (SB)]

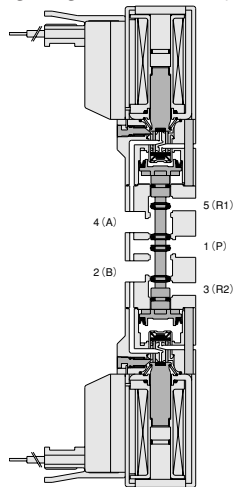

## Major Parts and Materials

	Parts	Materials
Valve	Body	Aluminum alloy (anodized)
	Stem	(anodized)
	Lip seal	Synthetic rubber
	Flapper	
	Mounting base	Steel (zinc plated)
	Sub-base	Aluminum alloy (anodized)
	Plunger	
	Column	Magnetic stainless
Manifold	End cover	Plastic
	Body	Aluminum alloy (anodized)
	Block-off plate	Steel (nickel plated)
	Seal	Synthetic rubber

## 5-port, 3-position

(Both 14 (SA) and 12 (SB) are de-energized)

### Closed center

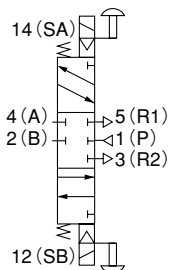

### HJC10F7

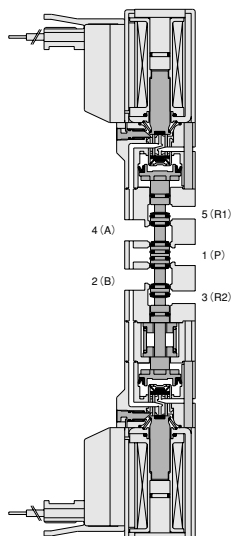

### Exhaust center

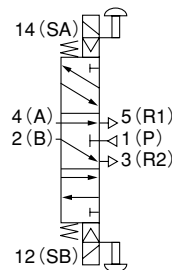

### HJC10F8

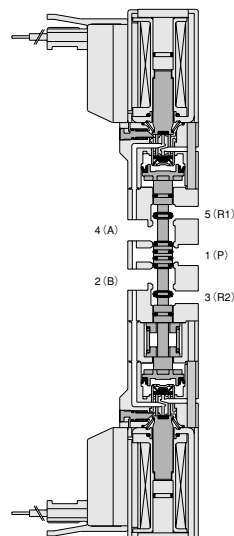

### Pressure center

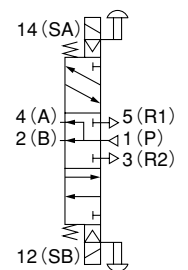

### HJC10F9

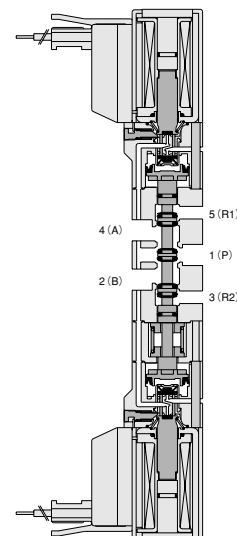

# HJC Series Single Valve Unit Order Code



## Valve specification

- F1, A1:** 2-port normally closed (NC)<sup>Note 1</sup>
- F2, A2:** 2-port normally open (NO)<sup>Note 1</sup>
- F3, A3:** 3-port normally closed (NC)<sup>Note 1</sup>
- F4, A4:** 3-port normally open (NO)<sup>Note 1</sup>
- F5, A5:** 5-port 2-position, single
- F6, A6:** 5-port 2-position, double
- F7, A7:** 3-position, closed center
- F8, A8:** 3-position, exhaust center
- F9, A9:** 3-position, pressure center

## Model

- HJC10**  
Standard type
- HJC10L**  
Low current type
- HJC10S**  
Quick response type

## Manual override

Non-locking type

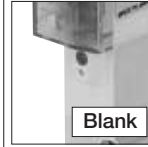

Locking type<sup>Note 2</sup>

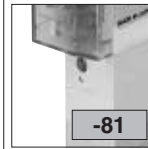

## Mounting base

Without mounting base

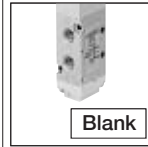

With mounting base

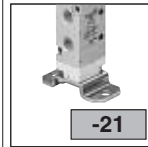

## Sub-base

Without sub-base

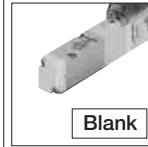

With sub-base

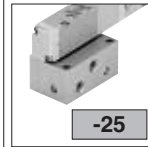

## Wiring specification

S type plug connector  
Lead wire 300mm [12in.]

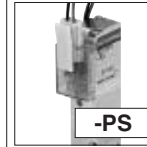

L type plug connector  
Lead wire 300mm [12in.]

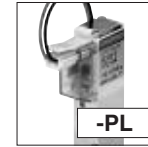

S type plug connector  
Lead wire 1000mm [39in.]

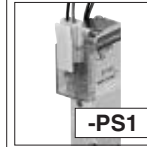

L type plug connector  
Lead wire 1000mm [39in.]

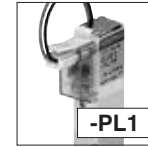

S type plug connector  
Lead wire 3000mm [118in.]



L type plug connector  
Lead wire 3000mm [118in.]



S type plug connector  
Without connector



L type plug connector  
Without connector

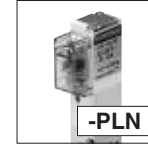

Grommet type<sup>Note 3</sup>  
Lead wire 300mm [12in.]  
(moisture-proof specification)

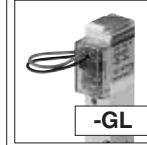

## Voltage

**-D4**

24VDC

**-D5**

12VDC<sup>Note 4</sup>

**-D6**

6VDC<sup>Note 4</sup>

**-D7**

5VDC<sup>Note 4</sup>

	Model	Valve specification	Mounting base	Sub-base	Manual override	Wiring specification	Voltage
Direct piping	HJC10 HJC10L HJC10S	F1 <sup>Note 1</sup> F2 <sup>Note 1</sup> F3 <sup>Note 1</sup> F4 <sup>Note 1</sup>  F5  F6 F7 F8 F9	Blank -21		Blank -81 <sup>Note 2</sup>	-PS -PS1 -PS3 -PSN -PL -PL1 -PL3 -PLN -GL <sup>Note 3</sup>	-D4 -D5 <sup>Note 4</sup> -D6 <sup>Note 4</sup> -D7 <sup>Note 4</sup>
Base piping	HJC10 HJC10L HJC10S	A1 <sup>Note 1</sup> A2 <sup>Note 1</sup> A3 <sup>Note 1</sup> A4 <sup>Note 1</sup>  A5 A6 A7 A8 A9		Blank -25	Blank -81 <sup>Note 2</sup>	-PS -PS1 -PS3 -PSN -PL -PL1 -PL3 -PLN -GL <sup>Note 3</sup>	-D4 -D5 <sup>Note 4</sup> -D6 <sup>Note 4</sup> -D7 <sup>Note 4</sup>

Notes: 1. Valves with valve specifications **F1, F2, F3, F4, A1, A2, A3, and A4** are for mounting on manifolds only, and cannot be used as a single valve unit.

2. The locking-type manual override is not available for the quick response type **HJC10S**.

3. The grommet type is not available for the low current type **HJC10L** and quick response type **HJC10S**.

4. The 5VDC, 6VDC and 12VDC specifications are not available for the low current type **HJC10L** and quick response type **HJC10S**.

# HJC Series Manifold Order Code

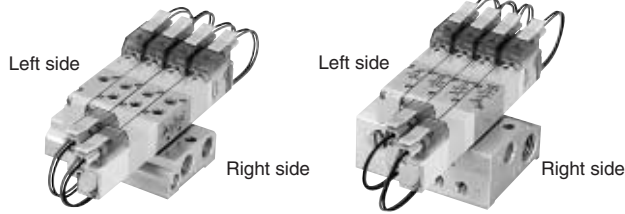

## Manifold specification

F type (direct piping type)

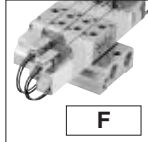

**F**

A type (base piping type)

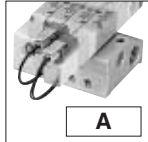

**A**

## Mounting type

Direct mounting



**Blank**

With DIN rail mounting bracket (A type manifold only)

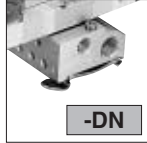

**-DN**

Mounting bracket is included.

## Valve specification

- F1, A1: 2-port normally closed (NC)
- F2, A2: 2-port normally open (NO)
- F3, A3: 3-port normally closed (NC)
- F4, A4: 3-port normally open (NO)
- F5, A5: 5-port 2-position, single
- F6, A6: 5-port 2-position, double
- F7, A7: 3-position, closed center
- F8, A8: 3-position, exhaust center
- F9, A9: 3-position, pressure center

## Manual override

Non-locking type

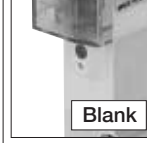

**Blank**

Locking type<sup>Note 2</sup>

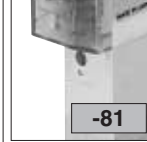

**-81**

## Wiring specification

S type plug connector  
Lead wire 300mm [12in.]

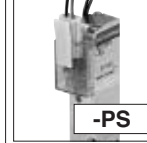

**-PS**

L type plug connector  
Lead wire 300mm [12in.]

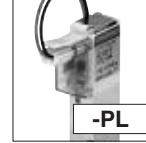

**-PL**

S type plug connector  
Lead wire 1000mm [39in.]

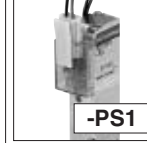

**-PS1**

L type plug connector  
Lead wire 1000mm [39in.]

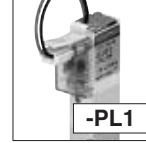

**-PL1**

S type plug connector  
Lead wire 3000mm [118in.]

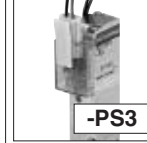

**-PS3**

L type plug connector  
Lead wire 3000mm [118in.]

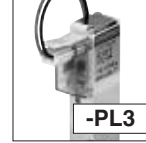

**-PL3**

S type plug connector  
Without connector



**-PSN**

L type plug connector  
Without connector

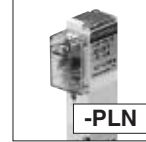

**-PLN**

Grommet type<sup>Note 3</sup>  
Lead wire 300mm [12in.]  
(moisture-proof specification)



**-GL**

## Voltage

**-D4**

24VDC

**-D5**

12VDC<sup>Note 4</sup>

**-D6**

6VDC<sup>Note 4</sup>

**-D7**

5VDC<sup>Note 4</sup>

Model	Number of units	Manifold specification	Mounting type	Station	Model	Valve specification	Manual override	Wiring specification	Voltage
-------	-----------------	------------------------	---------------	---------	-------	---------------------	-----------------	----------------------	---------

Manifold model				Mounting valve code					
F type manifold (direct piping type)	HJCM	2 . . . 20	F	stn. 1 . . . stn. <input type="checkbox"/> Note 1	HJC10 HJC10L HJC10S	F1 F2 F3 F4 F5 F6 F7 F8 F9	Blank -81 <sup>Note 2</sup>	-PS -PS1 -PS3 -PSN -PL -PL1 -PL3 -PLN -GL <sup>Note 3</sup>	-D4 -D5 <sup>Note 4</sup> -D6 <sup>Note 4</sup> -D7 <sup>Note 4</sup>
			HJCBP (for block-off plate)						
A type manifold (base piping type)	HJCM	2 . . . 20	A	stn. 1 . . . stn. <input type="checkbox"/> Note 1	HJC10 HJC10L HJC10S	A1 A2 A3 A4 A5 A6 A7 A8 A9	Blank -81 <sup>Note 2</sup>	-PS -PS1 -PS3 -PSN -PL -PL1 -PL3 -PLN -GL <sup>Note 3</sup>	-D4 -D5 <sup>Note 4</sup> -D6 <sup>Note 4</sup> -D7 <sup>Note 4</sup>
HJCBP (for block-off plate)									

Notes: 1. Valve mounting location is from the left side of manifold.  
 2. The locking-type manual override is not available for the quick response type HJC10S.  
 3. The grommet type is not available for the low current type HJC10L and quick response type HJC10S.  
 4. The 5VDC, 6VDC and 12VDC specifications are not available for the low current type HJC10L and quick response type HJC10S.

## HJC Series Additional Parts Order Code

---

**Block-off plate** (block-off plate and 2 mounting screws)

**HJCBP**

**Connector-related**

**HEAZ -** 

**Connector specification**

**P** : Connector, lead wire length 300mm [12in.]

**P1** : Connector, lead wire length 1000mm [39in.]

**P3** : Connector, lead wire length 3000mm [118in.]

**PN** : Connector, without lead wire (contacts included)

**DIN rail mounting bracket** (with screws)

**HJCZ -DN**



**Muffler** mm [in.]

**HKM-03** For in line valve

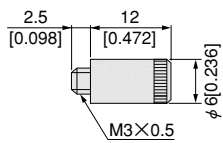

**HKM-05** For valve, sub-base and manifold

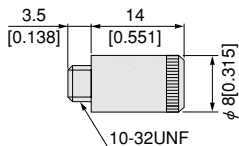

# HJC Series Dimensions of Single Valve Unit mm [in.]

## 5-port single solenoid HJC10 F5-PL

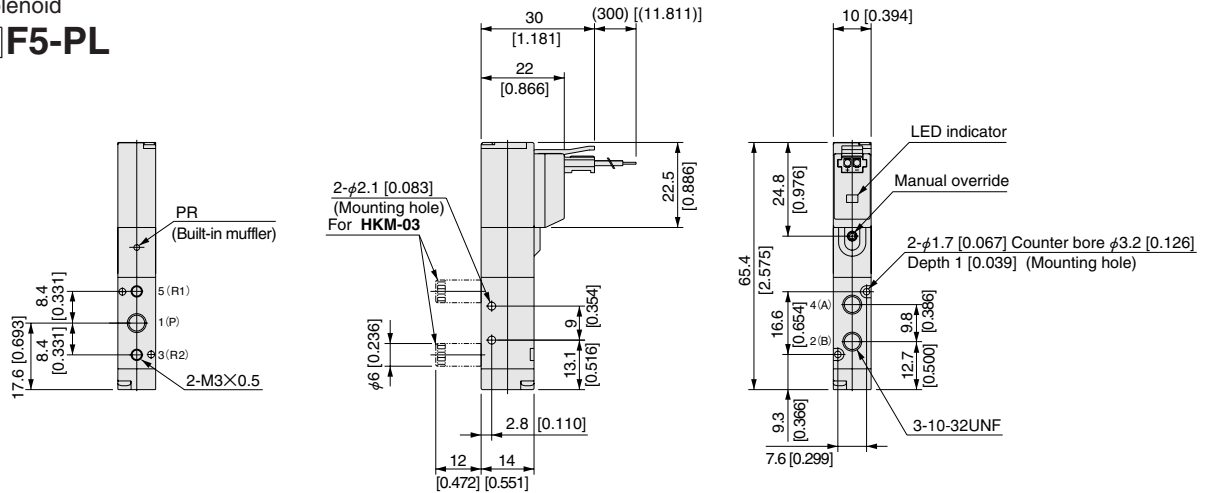

## 5-port single solenoid (with sub-base) HJC10 A5-25-PL

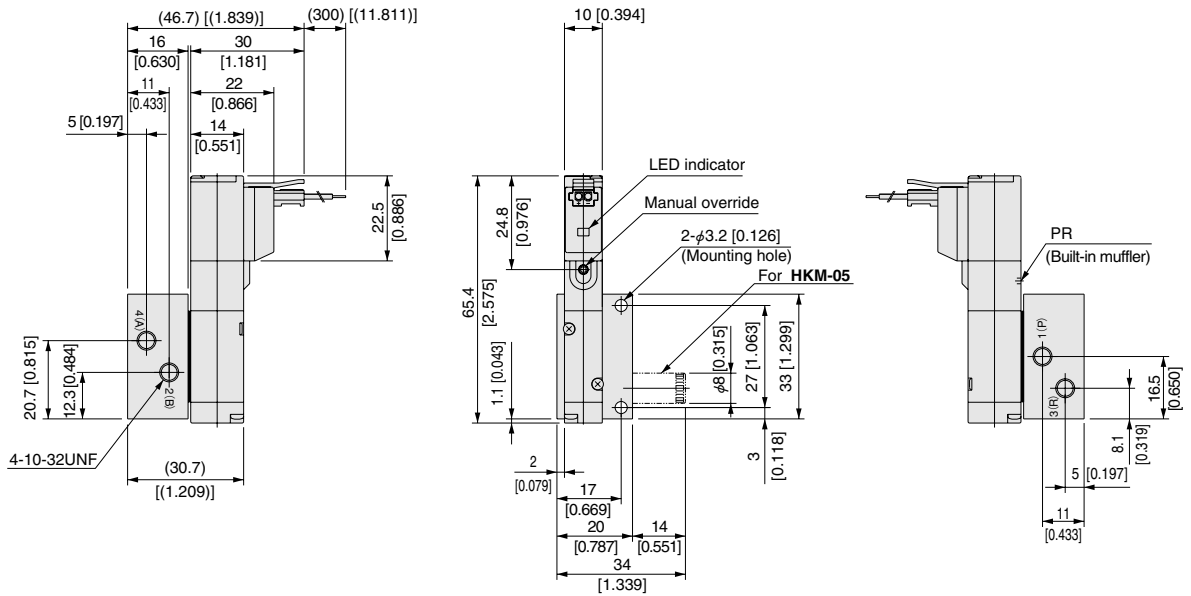

## Options

- Mounting base: **-21**
- Locking type manual override: **-81**
- Grommet: **-GL**
- S type plug connector: **-PS**

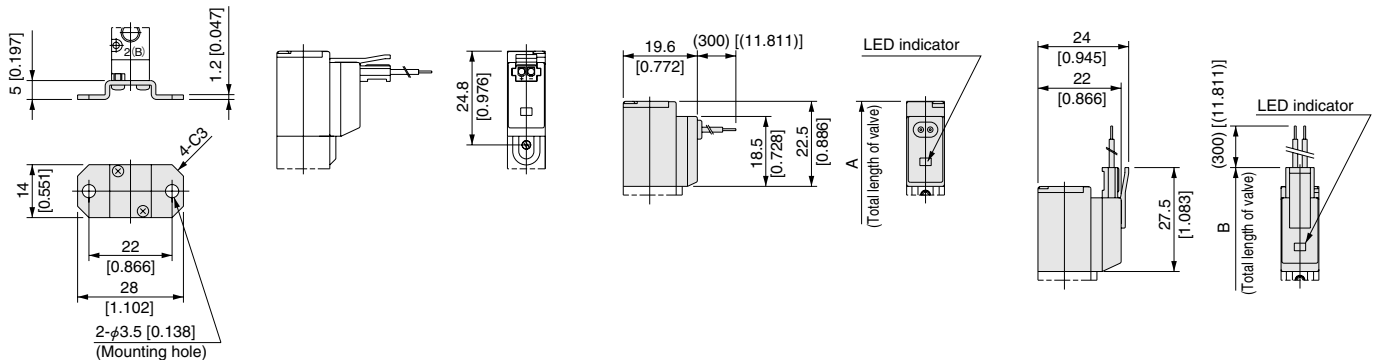

Model	Code	A	B	Remark
HJC10F5, HJC10A5		65.4 [2.575]	70.4 [2.772]	Length to the end of the valve
HJC10LF5, HJC10LA5, HJC10SF5, HJC10SA5		—	70.4 [2.772]	

mm [in.]

# HJC Series Dimensions of Single Valve Unit mm [in.]

## 5-port double solenoid HJC10 □ F6-PL

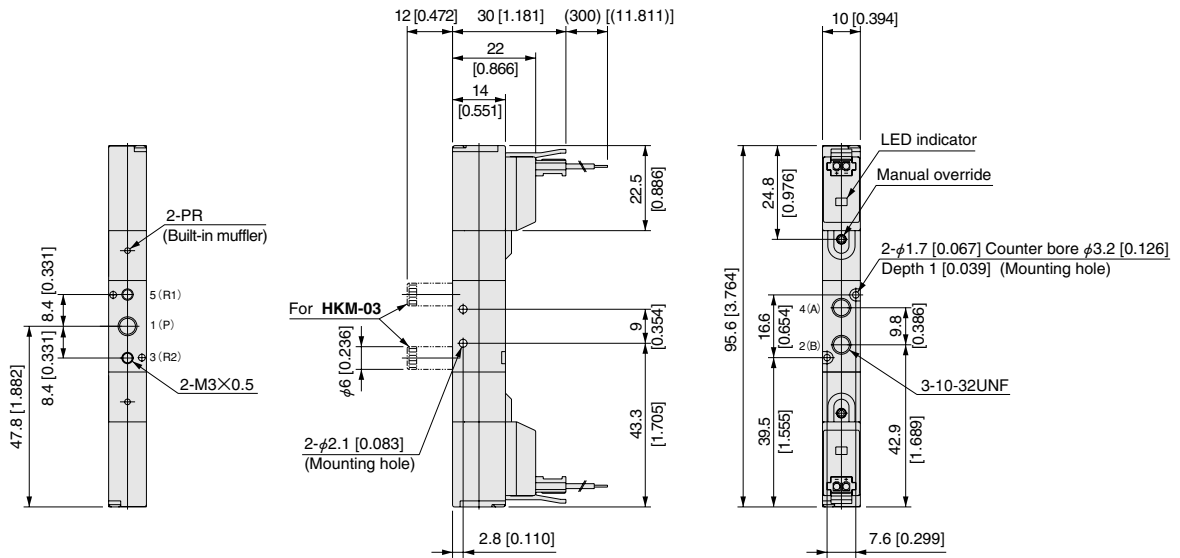

## 5-port double solenoid (with sub-base) HJC10 □ A6-25-PL

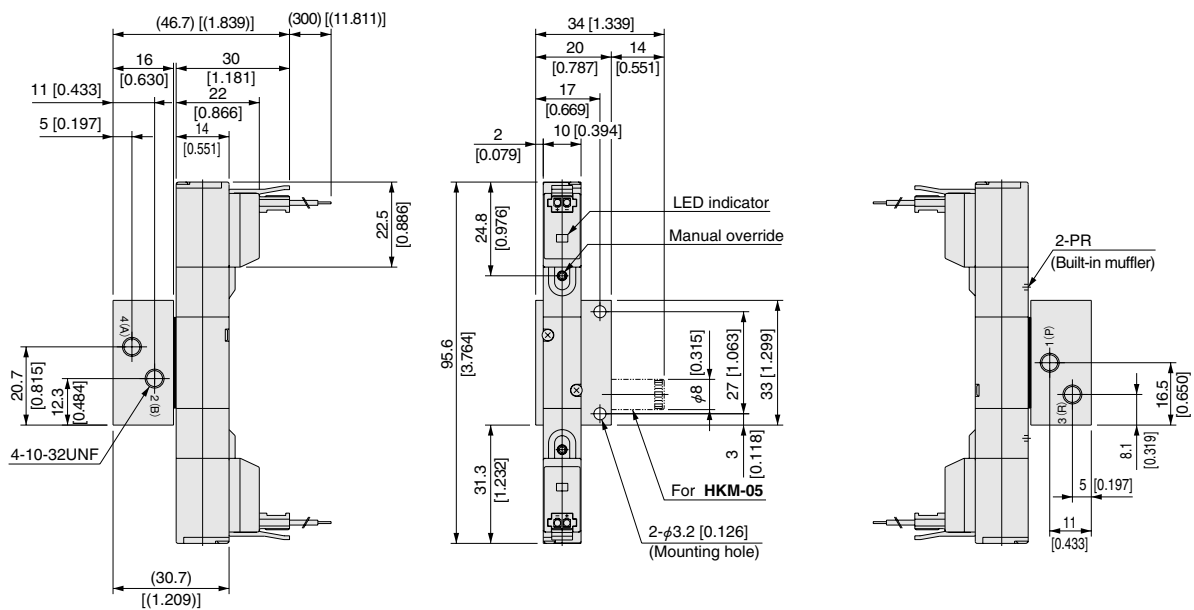

# HJC Series Dimensions of Single Valve Unit mm [in.]

5-port, 3-position

**HJC10** □ **F7-PL**

**HJC10** □ **F8-PL**

**HJC10** □ **F9-PL**

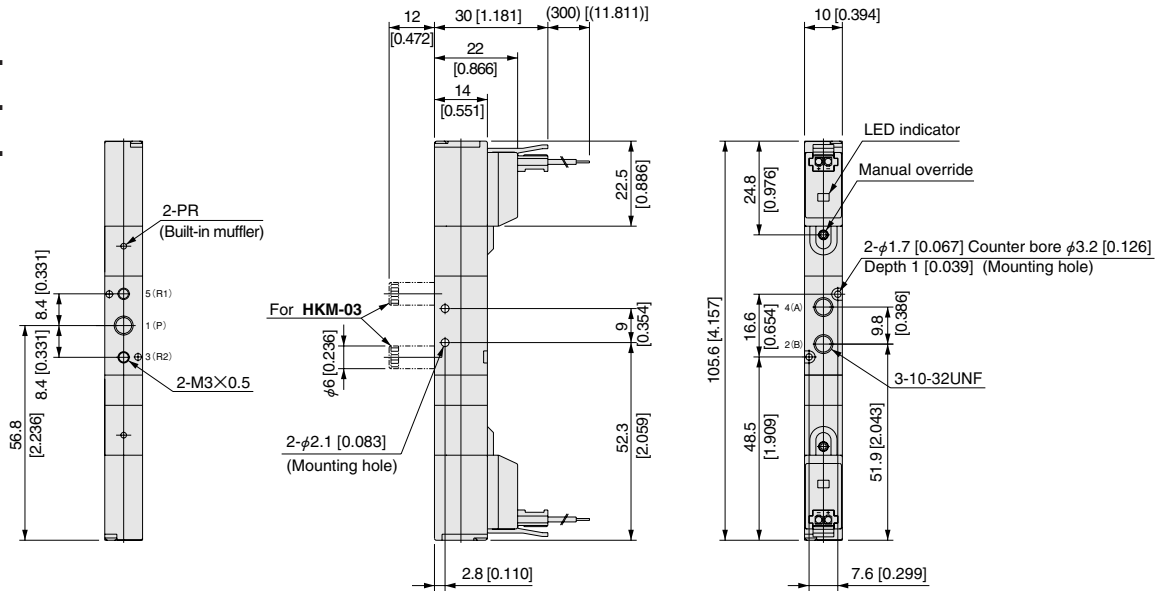

5-port, 3-position (with sub-base)

**HJC10** □ **A7-25-PL**

**HJC10** □ **A8-25-PL**

**HJC10** □ **A9-25-PL**

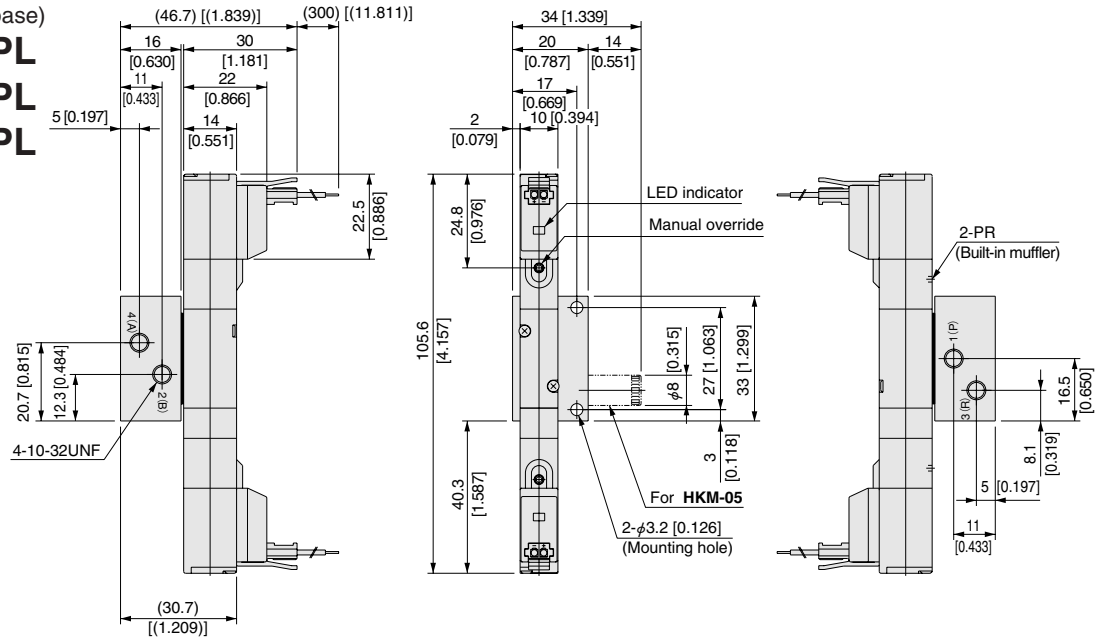

## Options

● Locking type manual override: **-81**

● Grommet: **-GL**

● S type plug connector: **-PS**

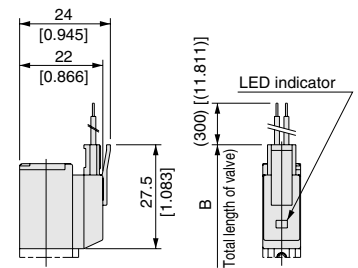
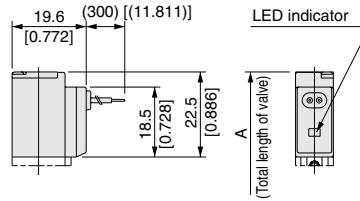
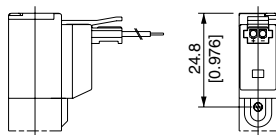

Model	Code	A	B	Remark
HJC10F6, HJC10A6		95.6 [3.764]	105.6 [4.157]	Length to the end of solenoid on opposite side
HJC10F7~HJC10F9, HJC10A7~HJC10A9		105.6 [4.157]	115.6 [4.551]	
HJC10LF6, HJC10LA6, HJC10SF6, HJC10SA6		—	105.6 [4.157]	
HJC10LF7~HJC10LF9, HJC10LA7~HJC10LA9		—	115.6 [4.551]	
HJC10SF7~HJC10SF9, HJC10SA7~HJC10SA9		—	115.6 [4.551]	

# HJC Series Dimensions of Manifold mm [in.]

Manifold with combined mounting of 2, 3, 5-port valves

## HJCM□F

(direct piping type)

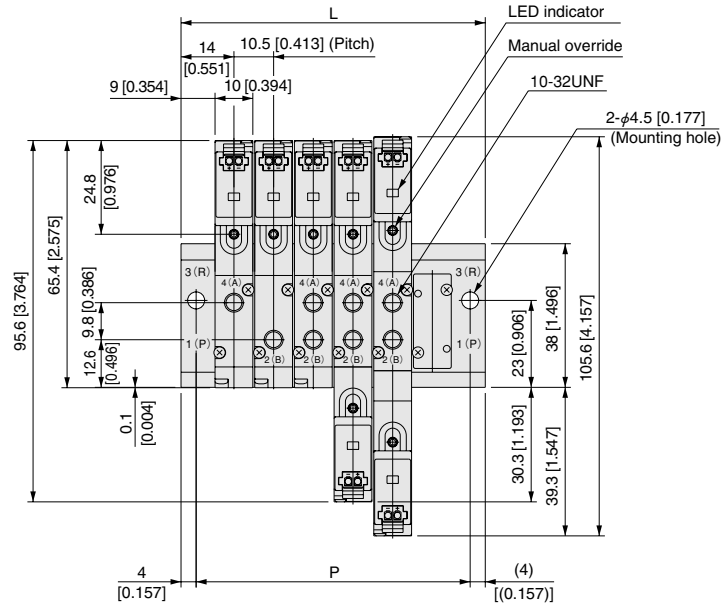
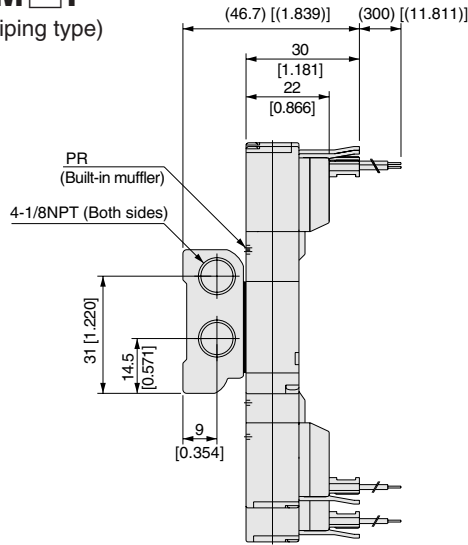

(Mounting example)

### HJCM6F

- stn.1 HJC10F3-PL-D4
- stn.2 HJC10F4-PL-D4
- stn.3 HJC10F5-PL-D4
- stn.4 HJC10F6-PL-D4
- stn.5 HJC10F7-PL-D4
- stn.6 HJCBP

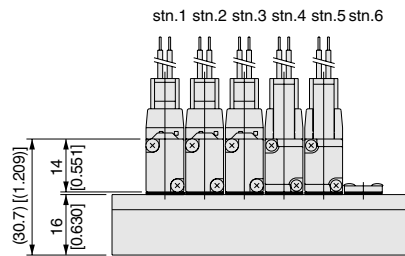

## Unit dimensions

Number of units	L	P
2	38.5 [1.516]	30.5 [1.201]
3	49.0 [1.929]	41.0 [1.614]
4	59.5 [2.343]	51.5 [2.028]
5	70.0 [2.756]	62.0 [2.441]
6	80.5 [3.169]	72.5 [2.854]
7	91.0 [3.583]	83.0 [3.268]
8	101.5 [3.996]	93.5 [3.681]
9	112.0 [4.409]	104.0 [4.094]
10	122.5 [4.823]	114.5 [4.508]
11	133.0 [5.236]	125.0 [4.921]
12	143.5 [5.650]	135.5 [5.335]
13	154.0 [6.063]	146.0 [5.748]
14	164.5 [6.476]	156.5 [6.161]
15	175.0 [6.890]	167.0 [6.575]
16	185.5 [7.303]	177.5 [6.988]
17	196.0 [7.717]	188.0 [7.402]
18	206.5 [8.130]	198.5 [7.815]
19	217.0 [8.543]	209.0 [8.228]
20	227.5 [8.957]	219.5 [8.642]



# HJC Series Dimensions of Manifold mm [in.]

## Manifold with combined mounting of 2, 3, 5-port valves

### HJCM □ A

(base piping type)

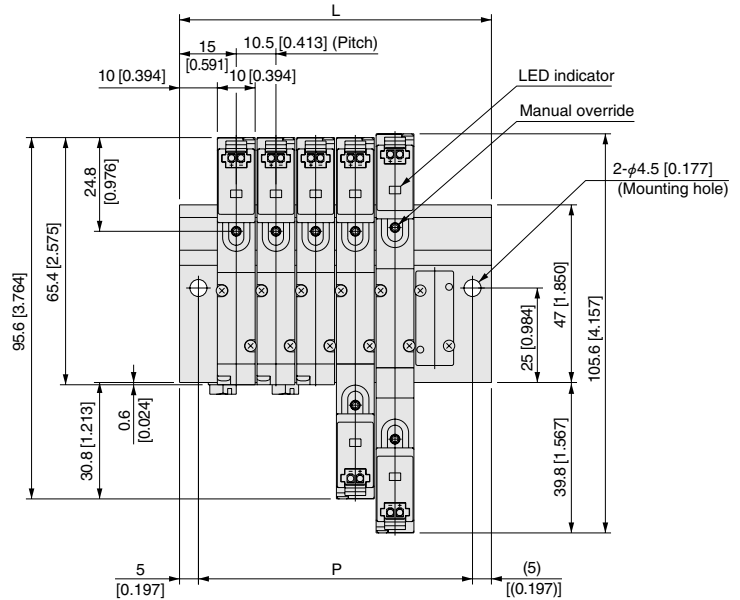
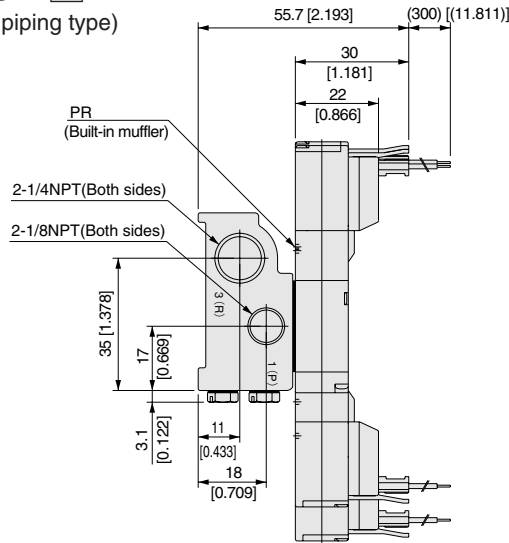

[Mounting example]

#### HJCM6A

- stn.1 HJC10A3-PL-D4
- stn.2 HJC10A4-PL-D4
- stn.3 HJC10A5-PL-D4
- stn.4 HJC10A6-PL-D4
- stn.5 HJC10A7-PL-D4
- stn.6 HJCBP

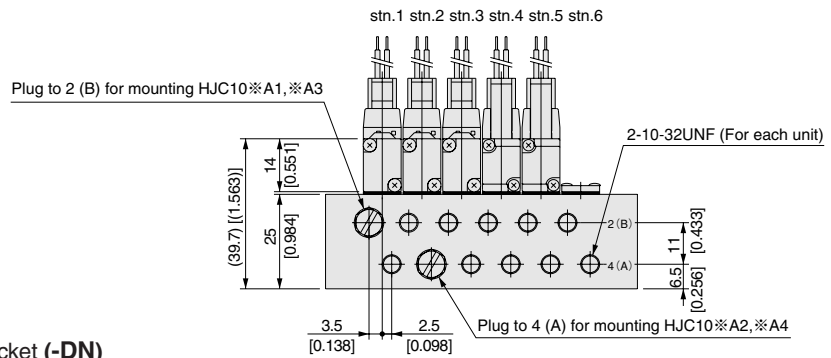

#### ● DIN rail mounting bracket (-DN)

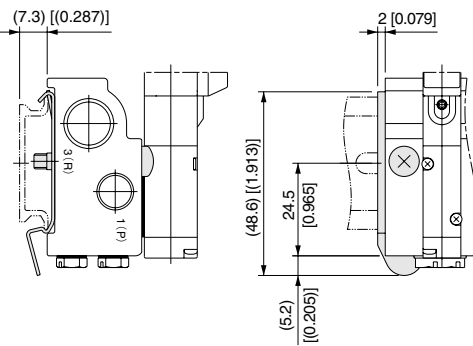

### Unit dimensions

Number of units	L	P
2	40.5 [1.594]	30.5 [1.201]
3	51.0 [2.008]	41.0 [1.614]
4	61.5 [2.421]	51.5 [2.028]
5	72.0 [2.835]	62.0 [2.441]
6	82.5 [3.248]	72.5 [2.854]
7	93.0 [3.661]	83.0 [3.268]
8	103.5 [4.075]	93.5 [3.681]
9	114.0 [4.488]	104.0 [4.094]
10	124.5 [4.902]	114.5 [4.508]
11	135.0 [5.315]	125.0 [4.921]
12	145.5 [5.728]	135.5 [5.335]
13	156.0 [6.142]	146.0 [5.748]
14	166.5 [6.555]	156.5 [6.161]
15	177.0 [6.968]	167.0 [6.575]
16	187.5 [7.382]	177.5 [6.988]
17	198.0 [7.795]	188.0 [7.402]
18	208.5 [8.209]	198.5 [7.815]
19	219.0 [8.622]	209.0 [8.228]
20	229.5 [9.035]	219.5 [8.642]



# HJE Series Solenoid Valves

# HJE

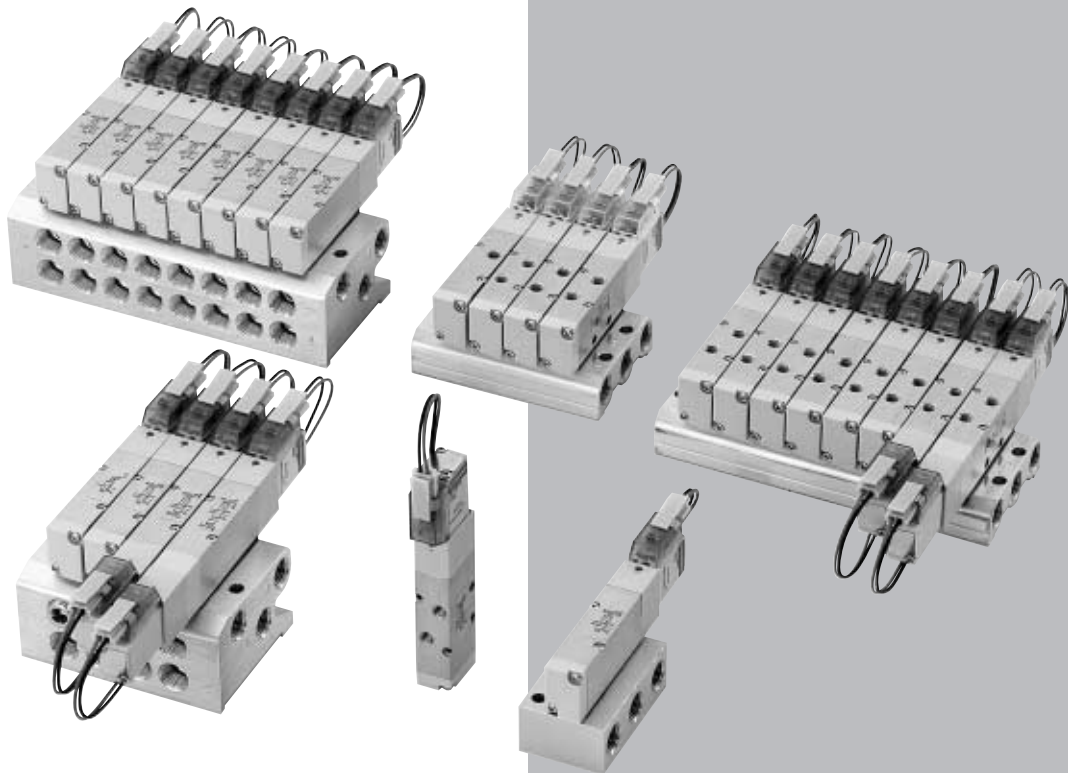

# HJE SERIES SPECIFICATIONS

## Specifications

### Basic Models and Functions

Item	Basic model	For direct piping and F type manifold	HJE12□F1 <sup>Note</sup> HJE12□F2 <sup>Note</sup> HJE12□F3 <sup>Note</sup> HJE12□F4 <sup>Note</sup>	HJE12□F5	HJE12□F6	HJE12□F7 HJE12□F8 HJE12□F9	
		For base piping and A type manifold	HJE12□A1 <sup>Note</sup> HJE12□A2 <sup>Note</sup> HJE12□A3 <sup>Note</sup> HJE12□A4 <sup>Note</sup>	HJE12□A5	HJE12□A6	HJE12□A7 HJE12□A8 HJE12□A9	
Number of positions		2 positions			3 positions		
Number of ports		2, 3 ports		5 ports			
Valve function		Single solenoid NC, NO	Single solenoid	Double solenoid	Closed center, exhaust center, pressure center		

Remark: For the optional specifications and order code, see p.55.

Note: Valves with valve specifications F1, F2, F3, F4, A1, A2, A3, and A4 are for mounting on manifolds only, and cannot be used as a single valve unit.

### Specifications

Item	Basic model	For direct piping and F type manifold	HJE12□F1 HJE12□F2 HJE12□F3 HJE12□F4	HJE12□F5	HJE12□F6	HJE12□F7 HJE12□F8 HJE12□F9
		For base piping and A type manifold	HJE12□A1 HJE12□A2 HJE12□A3 HJE12□A4	HJE12□A5	HJE12□A6	HJE12□A7 HJE12□A8 HJE12□A9
Media		Air				
Operation method		Internal pilot type				
Flow rate characteristics <sup>Note 1</sup>		Base piping (A type): 1.9				
Sonic conductance C dm <sup>3</sup> /(s · bar)						
Port size <sup>Note 2</sup>		Direct piping (F type): 10-32UNF, base piping (A type): 1/8NPT				
Lubrication		Not required				
Operating pressure range MPa {kgf/cm <sup>2</sup> }		0.2~0.7 {2~7.1} [29~102psi.]				
Proof pressure MPa {kgf/cm <sup>2</sup> }		1.05 {10.7} [152psi.]				
Response time <sup>Note 3</sup> ON/OFF	ms	Standard type	Max. 12/28	Max. 20	Max. 12/30	
		Low current type (L)	Max. 12/60	Max. 20	Max. 12/60	
		Quick response type (S)	Max. 6/10	Max. 8	Max. 6/10	
Maximum operating frequency	Hz	Standard type	5			
		Low current type (L)	2			
		Quick response type (S)	10			
Minimum time to energize for self holding <sup>Note 4</sup>		ms	—	50	—	
Operating temperature range (atmosphere and media)		°C [°F] 5~50 [41~122]				
Shock resistance m/s <sup>2</sup> {G}		1373.0 {140} (Axial direction 294.2 {30})		1373.0 {140} (Axial direction 245.0 {25})		
Mounting direction		Any				

Notes: 1. For details, see the flow rate characteristics on p.52.

2. For details, see the port size on p.53.

3. Values when air pressure is 0.5MPa [73psi.]. The values for the 3-position valves are those switching from neutral state.

4. For double solenoid valve.

### Solenoid Specifications

Item	Rated voltage	5VDC	6VDC	12VDC	24VDC	24VDC	24VDC	
		(Standard type)	(Standard type)	(Standard type)	(Standard type)	(Low current type)	(Quick response type)	
Operating voltage range	V	4.5~5.5 (5±10%)	5.4~6.6 (6±10%)	10.8~13.2 (12±10%)	21.6~26.4 (24±10%)	21.6~26.4 (24±10%)	21.6~26.4 (24±10%)	
Standard type	Current (When rated voltage is applied) mA (r.m.s)	110	92	46	23	—	—	
	Power consumption W	0.55	0.55	0.55	0.55	—	—	
Low current type Quick response type	Current (When rated voltage is applied)	Starting mA	—	—	—	23	125	
		Holding mA	—	—	—	6.3	46	
	Power consumption	Starting W	—	—	—	—	0.55	3
		Holding W	—	—	—	—	0.15	1.1
	Start-up time (standard time)	ms	—	—	—	—	Max. 200	Max. 30
Allowable leakage current	mA	4.8	4	2	1	0.5	4	
Insulation resistance	MΩ	Min. 100 (value at 500VDC megger)						
Color of LED indicator		Red						
Surge suppression (as standard)		Flywheel diode						

# Flow Rate Characteristics

The test method for flow rate characteristics conforms to JIS B 8390:2000 (test method for air pressure — equipment for compressible fluids — flow rate characteristics).

## ● When using as a single unit (with fitting)

Basic model		Flow channel	Sonic conductance C [dm <sup>3</sup> /(s·bar)]	Critical pressure ratio b	Effective area S <sup>Note 5</sup> [mm <sup>2</sup> ] [Cv]
Direct piping <sup>Note 1</sup>	HJE12□F5 HJE12□F6	1 (P) → 4 (A)	0.81	0.55	4.05 [0.23]
		1 (P) → 2 (B)	0.81	0.54	4.05 [0.23]
		4 (A) → 5 (R1)	0.75	0.44	3.75 [0.21]
	HJE12□F7 HJE12□F8 HJE12□F9	2 (B) → 3 (R2)	0.76	0.43	3.80 [0.21]
		1 (P) → 4 (A)	0.80	0.51	4.00 [0.23]
		1 (P) → 2 (B)	0.80	0.52	4.00 [0.23]
		4 (A) → 5 (R1)	0.71	0.41	3.55 [0.20]
		2 (B) → 3 (R2)	0.72	0.43	3.60 [0.20]
		2 (B) → 3 (R2)	1.28	0.14	6.40 [0.36]
Base piping <sup>Note 2</sup> (with sub-base)	HJE12□A5 HJE12□A6	1 (P) → 4 (A)	1.91	0.19	9.55 [0.54]
		1 (P) → 2 (B)	1.93	0.18	9.65 [0.54]
		4 (A) → 5 (R1)	1.90	0.15	9.50 [0.53]
		2 (B) → 3 (R2)	1.90	0.12	9.50 [0.53]
	HJE12□A7 HJE12□A8 HJE12□A9	1 (P) → 4 (A)	1.42	0.20	7.10 [0.40]
		1 (P) → 2 (B)	1.49	0.21	7.45 [0.42]
		4 (A) → 5 (R1)	1.37	0.18	6.85 [0.39]
		2 (B) → 3 (R2)	1.28	0.14	6.40 [0.36]
		2 (B) → 3 (R2)	1.28	0.14	6.40 [0.36]

## ● When mounted on a manifold (with fitting)

Basic model		Flow channel	Sonic conductance C [dm <sup>3</sup> /(s·bar)]	Critical pressure ratio b	Effective area S <sup>Note 5</sup> [mm <sup>2</sup> ] [Cv]		
F type manifold <sup>Note 3</sup> (direct piping type)	HJE12□F1 HJE12□F2 HJE12□F3 HJE12□F4 HJE12□F5 HJE12□F6	1 (P) → 4 (A)	0.88	0.64	4.40 [0.25]		
		1 (P) → 2 (B)	0.88	0.63	4.40 [0.25]		
		4 (A) → 5 (R1)	0.90	0.20	4.50 [0.25]		
		2 (B) → 3 (R2)	0.91	0.20	4.55 [0.26]		
		1 (P) → 4 (A)	0.84	0.59	4.20 [0.24]		
		1 (P) → 2 (B)	0.85	0.59	4.25 [0.24]		
	HJE12□F7 HJE12□F8 HJE12□F9	4 (A) → 5 (R1)	0.85	0.20	4.25 [0.24]		
		2 (B) → 3 (R2)	0.85	0.21	4.25 [0.24]		
		A type manifold <sup>Note 4</sup> (base piping type)	HJE12□A1 HJE12□A2 HJE12□A3 HJE12□A4 HJE12□A5 HJE12□A6	1 (P) → 4 (A)	1.62	0.38	8.10 [0.46]
				1 (P) → 2 (B)	1.63	0.38	8.15 [0.46]
				4 (A) → 5 (R1)	1.82	0.10	9.10 [0.51]
			HJE12□A7 HJE12□A8 HJE12□A9	2 (B) → 3 (R2)	1.77	0.18	8.85 [0.50]
1 (P) → 4 (A)	1.34			0.40	6.70 [0.38]		
1 (P) → 2 (B)	1.37			0.24	6.85 [0.39]		
HJE12□A8 HJE12□A9	4 (A) → 5 (R1)	1.34	0.08	6.70 [0.38]			
	2 (B) → 3 (R2)	1.26	0.17	6.30 [0.35]			

- Notes: 1. Quick fitting TSH6-M5M has been mounted on connection ports 1(P), 2(B), and 4(A).  
 2. Quick fitting TS8-01 has been mounted on connection ports 1(P), 2(B), and 4(A).  
 3. Quick fitting TSH6-M5M has been mounted on connection ports 2(B) and 4(A).  
 4. Quick fitting TS6-01M has been mounted on connection ports 2(B) and 4(A).  
 5. Figures in effective area S calculated based on sonic conductance C ( $S=5.0 \times C$ ).

**Base piping type**  
(Effective area S = 9.5mm<sup>2</sup> [Cv: 0.53])

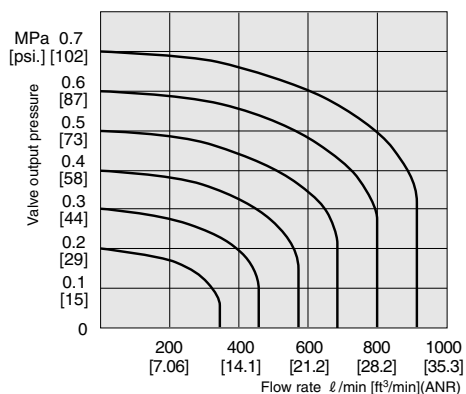

**Direct piping type**  
(Effective area S = 4.4mm<sup>2</sup> [Cv: 0.25])

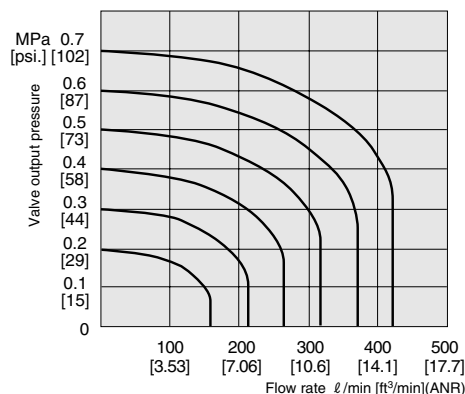

- Graphs use flow rate calculations based on the radiation method.
- Treat the flow rate as a general standard.

## Port Size

Specifications	Ports	2 (B), 4 (A)	1 (P)	3·5 (R)
Single unit	Direct piping	10-32UNF	10-32UNF	10-32UNF
	Base piping (with sub-base)	1/8NPT	1/8NPT	1/8NPT
Manifold	F type	10-32UNF	1/8NPT	1/8NPT
	A type	1/8NPT	1/8NPT	1/8NPT

## Mass

### Single Valve Unit Mass

g [oz]

Basic model	Mass	Additional mass		
		-21 (with bottom mounting base)	-22 (with side mounting base)	-25 (with sub-base)
HJE12□F1	39 [1.37]	—	—	—
HJE12□F2				
HJE12□F3				
HJE12□F4				
HJE12□F5	36 [1.27]	6 [0.21]	5 [0.18]	—
HJE12□F6	52 [1.83]			
HJE12□F7	55 [1.94]	—	5 [0.18]	—
HJE12□F8				
HJE12□F9				
HJE12□A1	39 [1.37]	—	—	—
HJE12□A2				
HJE12□A3				
HJE12□A4				
HJE12□A5	36 [1.27]	—	—	48 [1.69]
HJE12□A6	52 [1.83]			
HJE12□A7	55 [1.94]	—	—	48 [1.69]
HJE12□A8				
HJE12□A9				

### Manifold Mass

g [oz]

Basic model	Mass calculation of each unit (n = number of units)	Block-off plate	With DIN rail mounting bracket
HJEM□F	$(13 [0.46] \times n) + 17 [0.60]$	7 [0.25]	—
HJEM□A	$(32 [1.13] \times n) + 59 [2.08]$		15 [0.53]

Calculation example: **HJEM8A**

**stn.1~8 HJE12A5-PS-D4**

$$(32 \times 8) + 59 + (36 \times 8) = 603\text{g}$$

$$[(1.13 \times 8) + 2.08 + (1.27 \times 8) = 21.28\text{oz}]$$

## 5-port, 2-position

### Single solenoid

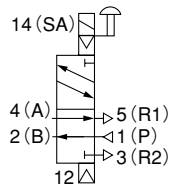

### HJE12F5

De-energized

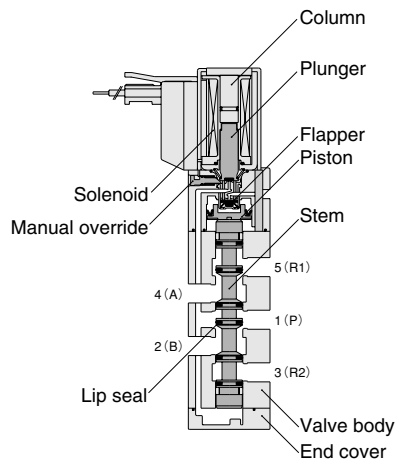

### Double solenoid

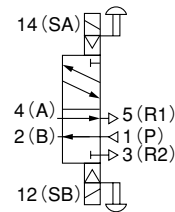

### HJE12F6

[De-energized condition after energizing solenoid 12 (SB)]

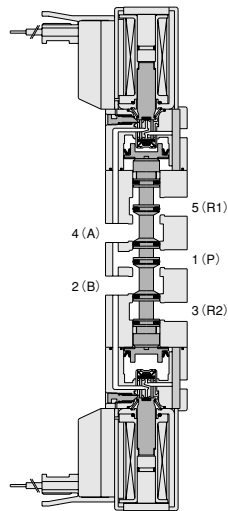

## Major Parts and Materials

Parts	Materials
Body	Aluminum alloy
Stem	(anodized)
Lip seal	Synthetic rubber
Flapper	
Valve	
Mounting base	Steel (nickel plated)
Sub-base	Aluminum alloy (anodized)
Plunger	Magnetic stainless
Column	
End cover	Plastic
Manifold	
Body	Aluminum alloy (anodized)
Block-off plate	Steel (nickel plated)
Seal	Synthetic rubber

## 5-port, 3-position

[Both 14 (SA) and 12 (SB) are de-energized]

### Closed center

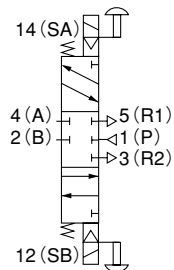

### HJE12F7

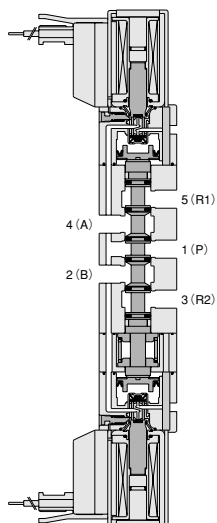

### Exhaust center

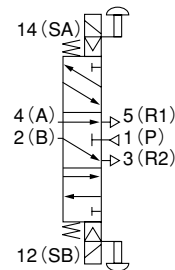

### HJE12F8

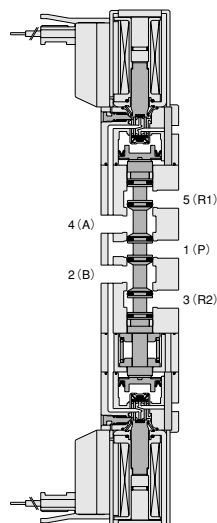

### Pressure center

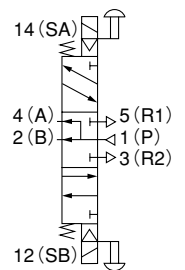

### HJE12F9

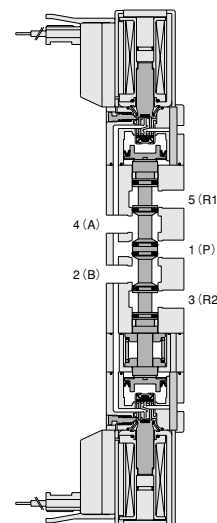

# HJE Series Single Valve Unit Order Code



## Valve specification

- F1, A1:** 2-port normally closed (NC)<sup>Note 1</sup>
- F2, A2:** 2-port normally open (NO)<sup>Note 1</sup>
- F3, A3:** 3-port normally closed (NC)<sup>Note 1</sup>
- F4, A4:** 3-port normally open (NO)<sup>Note 1</sup>
- F5, A5:** 5-port 2-position, single
- F6, A6:** 5-port 2-position, double
- F7, A7:** 3-position, closed center
- F8, A8:** 3-position, exhaust center
- F9, A9:** 3-position, pressure center

## Model

**HJE12**

Standard type

**HJE12L**

Low current type

**HJE12S**

Quick response type

## Mounting base

Without mounting base

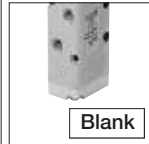

With mounting base (for bottom mounting)



With mounting base (for side mounting)



Mounting base for side mounting is included.

## Sub-base

Without sub-base



With sub-base



## Manual override

Non-locking type

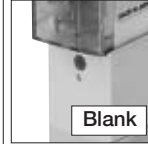

Locking type<sup>Note 2</sup>



Lever type (with prevention of incorrect operations)

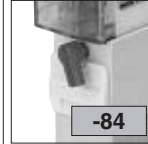

## Wiring specification

S type plug connector  
Lead wire 300mm [12in.]

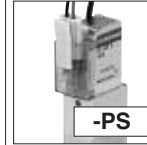

L type plug connector  
Lead wire 300mm [12in.]

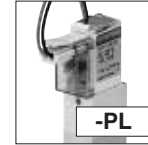

S type plug connector  
Lead wire 1000mm [39in.]

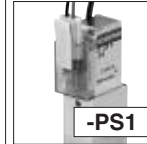

L type plug connector  
Lead wire 1000mm [39in.]

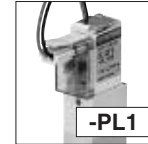

S type plug connector  
Lead wire 3000mm [118in.]

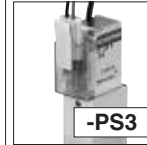

L type plug connector  
Lead wire 3000mm [118in.]

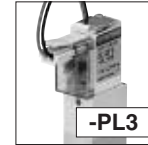

S type plug connector  
Without connector



L type plug connector  
Without connector

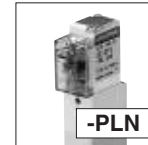

Grommet type<sup>Note 3</sup>  
Lead wire 300mm [12in.]  
(moisture-proof specification)



## Voltage

**-D4**

24VDC

**-D5**

12VDC<sup>Note 4</sup>

**-D6**

6VDC<sup>Note 4</sup>

**-D7**

5VDC<sup>Note 4</sup>

	Model	Valve specification	Mounting base	Sub-base	Manual override	Wiring specification	Voltage
Direct piping	HJE12 HJE12L HJE12S	F1 <sup>Note 1</sup> F2 <sup>Note 1</sup> F3 <sup>Note 1</sup> F4 <sup>Note 1</sup>	Blank -21 -22		Blank -81 <sup>Note 2</sup> -84	-PS -PS1 -PS3 -PL -PL1 -PL3 -PLN -GL <sup>Note 3</sup>	-D4 -D5 <sup>Note 4</sup> -D6 <sup>Note 4</sup> -D7 <sup>Note 4</sup>
		F5  F6 F7 F8 F9	Blank -22				
Base piping	HJE12 HJE12L HJE12S	A1 <sup>Note 1</sup> A2 <sup>Note 1</sup> A3 <sup>Note 1</sup> A4 <sup>Note 1</sup>			Blank -81 <sup>Note 2</sup> -84	-PS -PS1 -PS3 -PLN -PL -PL1 -PL3 -PLN -GL <sup>Note 3</sup>	-D4 -D5 <sup>Note 4</sup> -D6 <sup>Note 4</sup> -D7 <sup>Note 4</sup>
		A5 A6 A7 A8 A9		Blank -25			

Notes: 1. Valves with valve specifications F1, F2, F3, F4, A1, A2, A3, and A4 are for mounting on manifolds only, and cannot be used as a single valve unit.

2. The locking-type manual override is not available for the quick response type HJE12S.

3. The grommet type is not available for the low current type HJE12L and quick response type HJE12S.

4. The 5VDC, 6VDC and 12VDC specifications are not available for the low current type HJE12L and quick response type HJE12S.



# HJE Series Manifold Order Code

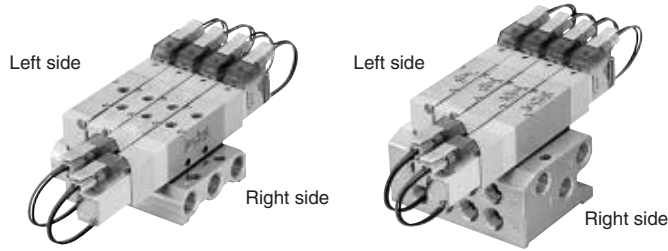

### Manifold specification

F type (direct piping type)

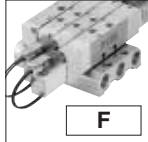

**F**

A type (base piping type)

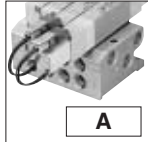

**A**

### Mounting type

Direct mounting



**Blank**

With DIN rail mounting bracket (A type manifold only)



**-DN**

Mounting bracket is included.

### Valve specification

- F1, A1: 2-port normally closed (NC)
- F2, A2: 2-port normally open (NO)
- F3, A3: 3-port normally closed (NC)
- F4, A4: 3-port normally open (NO)
- F5, A5: 5-port 2-position, single
- F6, A6: 5-port 2-position, double
- F7, A7: 3-position, closed center
- F8, A8: 3-position, exhaust center
- F9, A9: 3-position, pressure center

### Manual override

Non-locking type

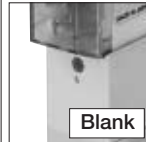

**Blank**

Locking type<sup>Note 2</sup>

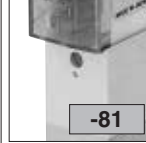

**-81**

Lever type (with prevention of incorrect operations)



**-84**

### Wiring specification

S type plug connector

Lead wire 300mm [12in.]

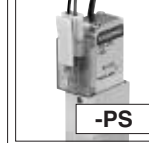

**-PS**

L type plug connector

Lead wire 300mm [12in.]

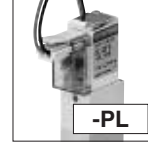

**-PL**

S type plug connector

Lead wire 1000mm [39in.]

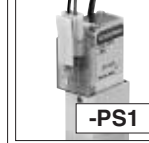

**-PS1**

L type plug connector

Lead wire 1000mm [39in.]

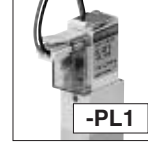

**-PL1**

S type plug connector

Lead wire 3000mm [118in.]

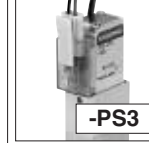

**-PS3**

L type plug connector

Lead wire 3000mm [118in.]

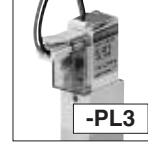

**-PL3**

S type plug connector

Without connector



**-PSN**

L type plug connector

Without connector



**-PLN**

Grommet type<sup>Note 3</sup>

Lead wire 300mm [12in.]

(moisture-proof specification)



**-GL**

### Voltage

**-D4**

24VDC

**-D5**

12VDC<sup>Note 4</sup>

**-D6**

6VDC<sup>Note 4</sup>

**-D7**

5VDC<sup>Note 4</sup>

### Model

**HJE12**

Standard type

**HJE12L**

Low current type

**HJE12S**

Quick response type

Model	Number of units	Manifold specification	Mounting type	Station	Model	Valve specification	Manual override	Wiring specification	Voltage
Manifold model				Mounting valve code					

F type manifold (direct piping type)	HJEM	2 . . . 20	F	stn.1 . . . stn.□ Note 1	HJE12 HJE12L HJE12S	F1 F2 F3 F4 F5 F6 F7 F8 F9	Blank -81 <sup>Note 2</sup> -84	-PS -PS1 -PS3 -PSN -PL -PL1 -PL3 -PLN -GL <sup>Note 3</sup>	-D4 -D5 <sup>Note 4</sup> -D6 <sup>Note 4</sup> -D7 <sup>Note 4</sup>
			HJEBP (for block-off plate)						
A type manifold (base piping type)	HJEM	2 . . . 20	A	stn.1 . . . stn.□ Note 1	HJE12 HJE12L HJE12S	A1 A2 A3 A4 A5 A6 A7 A8 A9	Blank -81 <sup>Note 2</sup> -84	-PS -PS1 -PS3 -PSN -PL -PL1 -PL3 -PLN -GL <sup>Note 3</sup>	-D4 -D5 <sup>Note 4</sup> -D6 <sup>Note 4</sup> -D7 <sup>Note 4</sup>
HJEBP (for block-off plate)									

Notes: 1. Valve mounting location is from the left side of manifold.

2. The locking-type manual override is not available for the quick response type HJE12S.

3. The grommet type is not available for the low current type HJE12L and quick response type HJE12S.

4. The 5VDC, 6VDC and 12VDC specifications are not available for the low current type HJE12L and quick response type HJE12S.

## HJE Series Additional Parts Order Code

---

**Block-off plate** (block-off plate and 2 mounting screws)

**HJEBP**

**Connector-related**

**HEAZ -** 

**Connector specification**

**P** : Connector, lead wire length 300mm [12in.]

**P1** : Connector, lead wire length 1000mm [39in.]

**P3** : Connector, lead wire length 3000mm [118in.]

**PN** : Connector, without lead wire (contacts included)

**DIN rail mounting bracket** (with screws)

**HJEZ -DN**



**Muffler** mm [in.]

**HKM-03** For in line valve

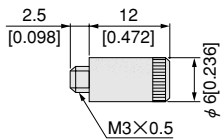

**HKM-05** For valve, sub-base and manifold

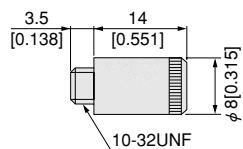

# HJE Series Dimensions of Single Valve Unit mm [in.]

## 5-port single solenoid HJE12 □ F5-PL

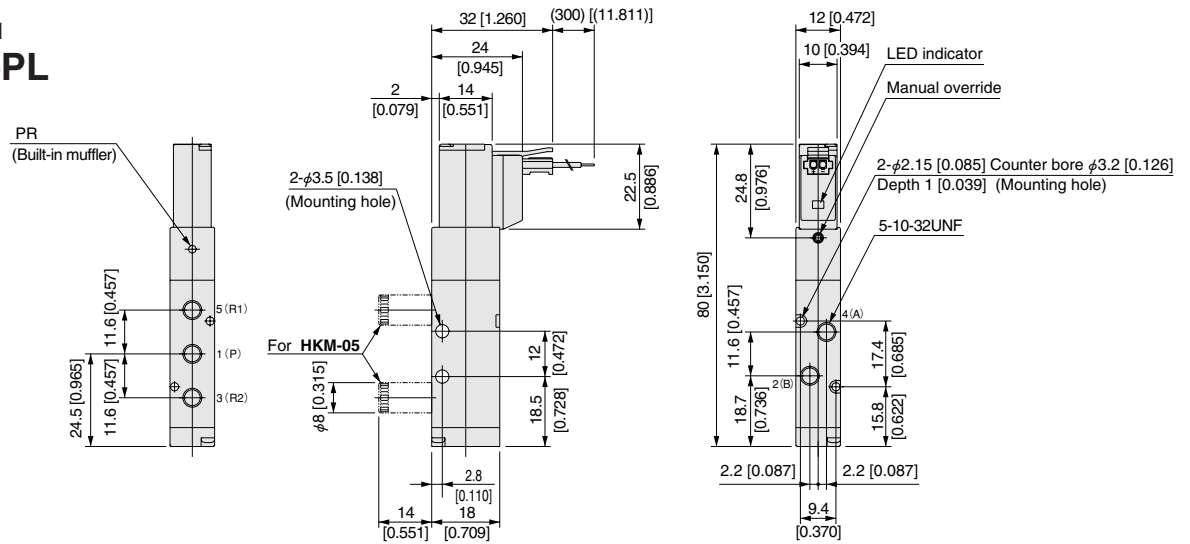

## 5-port single solenoid (with sub-base) HJE12 □ A5-25-PL

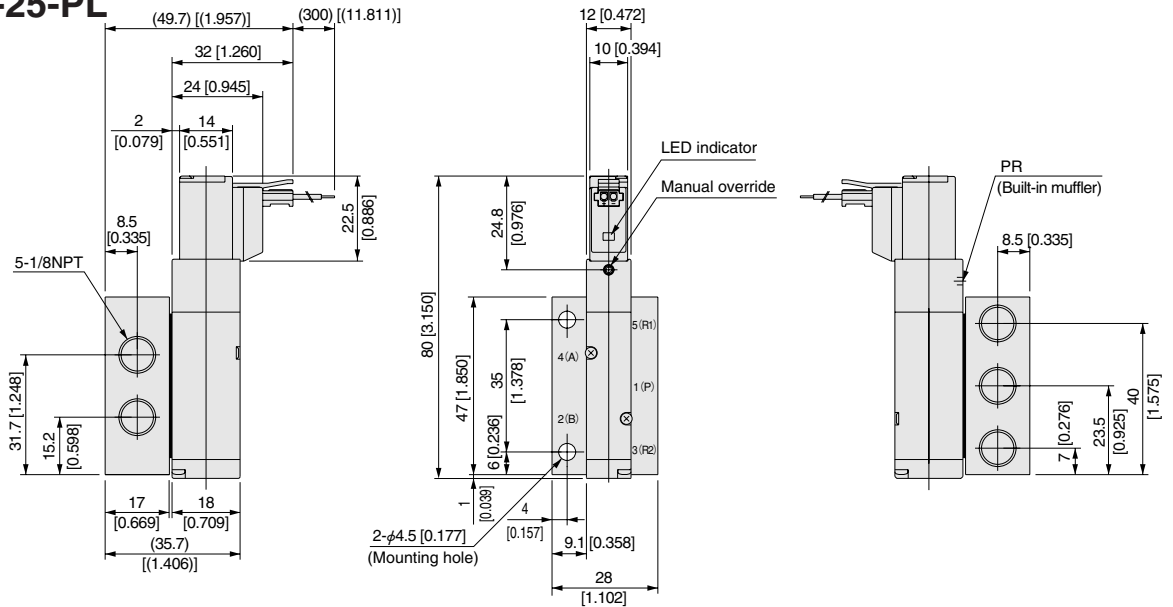

## Options

### ● Mounting base: -21

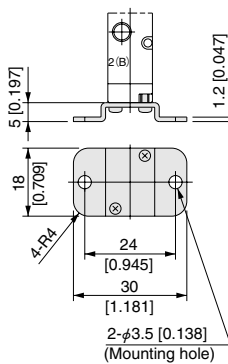

### ● Mounting base: -22 (for side mounting)

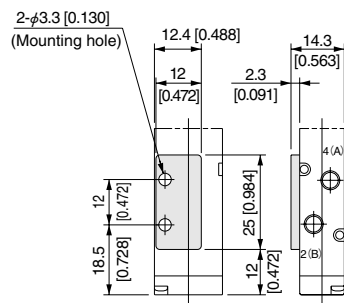

### ● Locking type manual override: -81

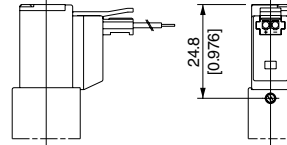

### ● Lever type manual override: -84

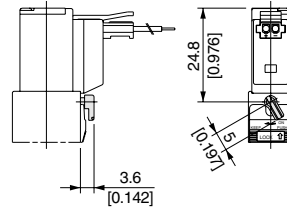

### ● Grommet: -GL

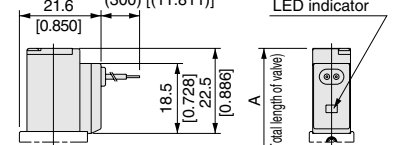

### ● S type plug connector: -PS

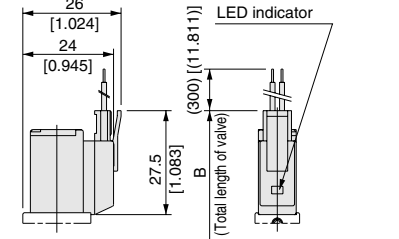

Model	Code	A	B	Remark
HJE12F5, HJE12A5		80 [3.150]	85 [3.346]	Length to the end of the valve
HJE12LF5, HJE12LA5, HJE12SF5, HJE12SA5		—	85 [3.346]	

# HJE Series Dimensions of Single Valve Unit mm [in.]

## 5-port double solenoid HJE12 F6-PL

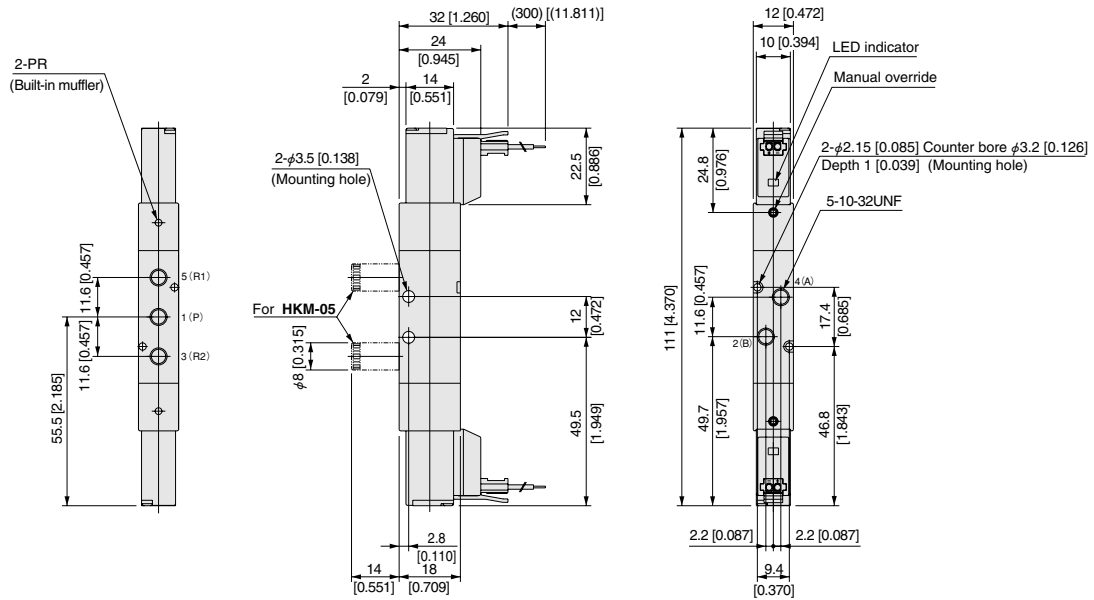

## 5-port double solenoid (with sub-base) HJE12 A6-25-PL

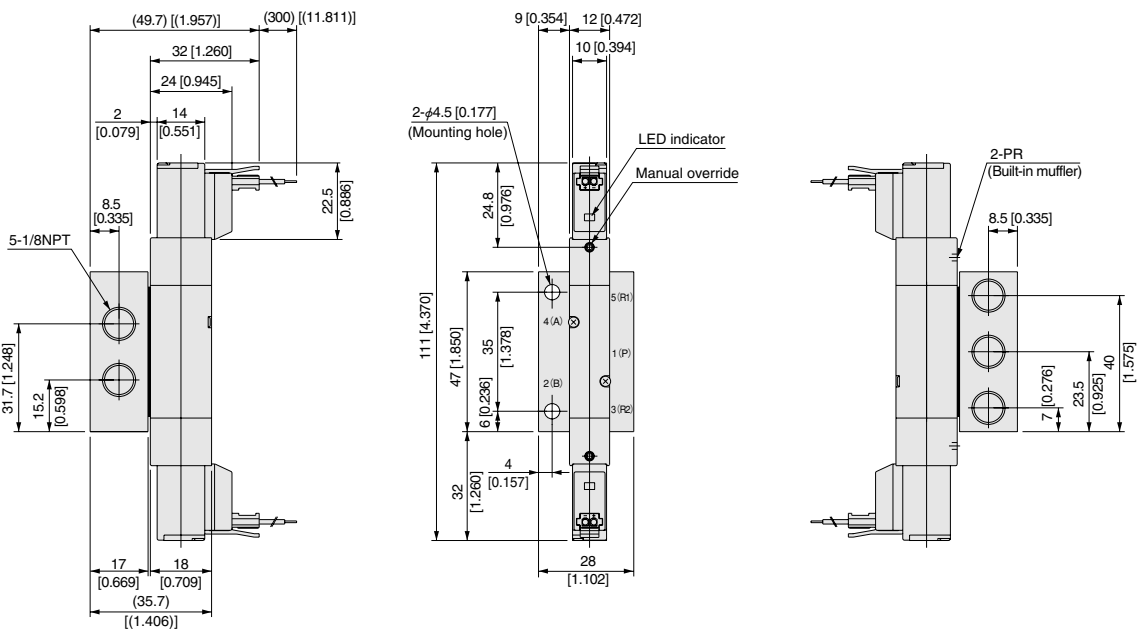

# HJE Series Dimensions of Single Valve Unit mm [in.]

5-port, 3-position

- HJE12□ F7-PL
- HJE12□ F8-PL
- HJE12□ F9-PL

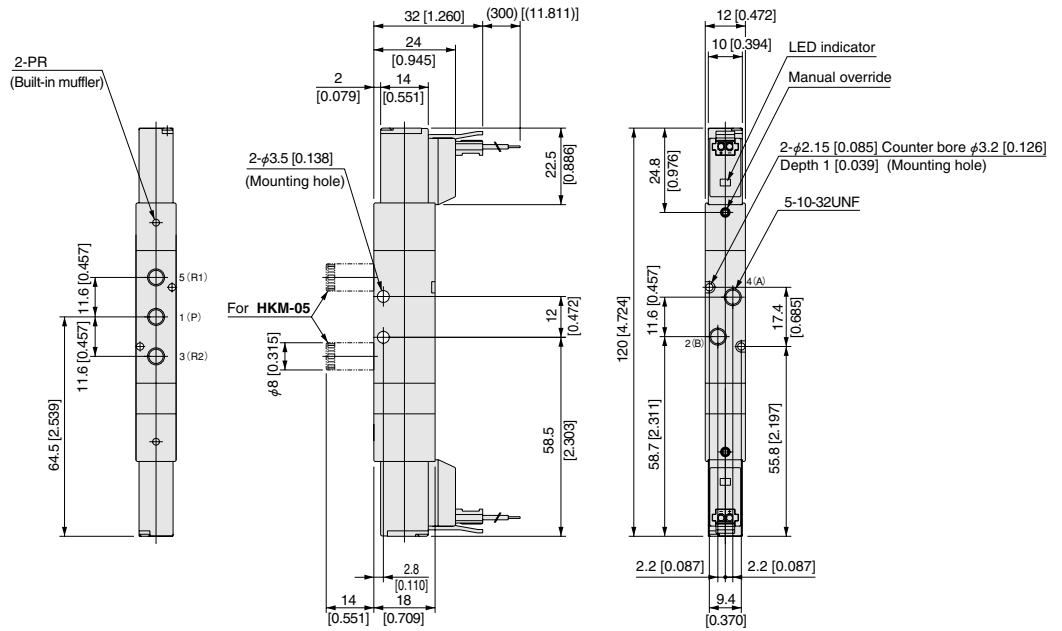

5-port, 3-position (with sub-base)

- HJE12□ A7-25-PL
- HJE12□ A8-25-PL
- HJE12□ A9-25-PL

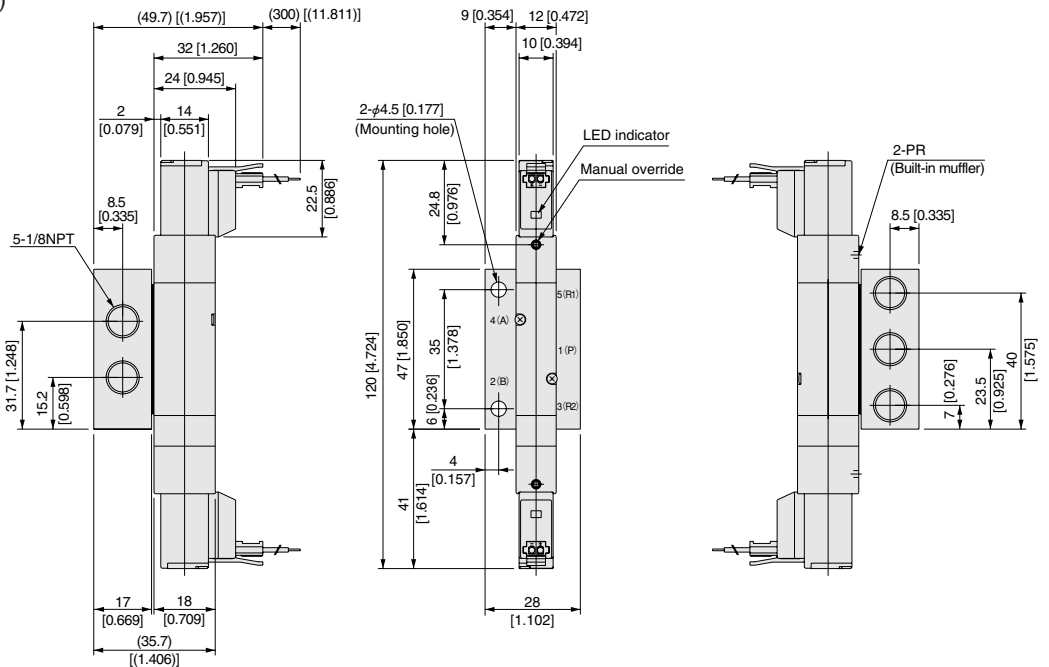

## Options

- Mounting base: -22 (for side mounting)
- Locking type manual override: -81
- Lever type manual override: -84
- Grommet: -GL
- S type plug connector: -PS

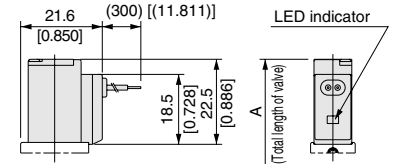
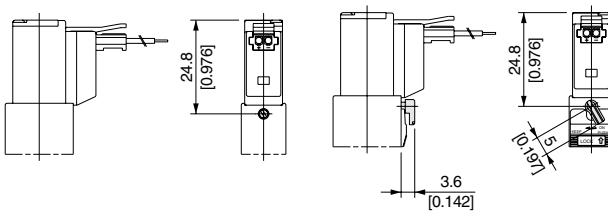
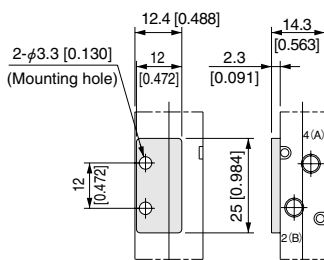

- S type plug connector: -PS

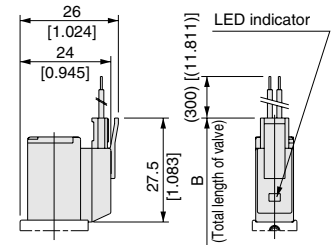

Model	Code	A	B	Remark
HJE12F6, HJE12A6		111 [4.370]	121 [4.764]	
HJE12F7~HJE12F9, HJE12A7~HJE12A9		120 [4.724]	130 [5.118]	Length to the end of solenoid on opposite side
HJE12LF6, HJE12LA6, HJE12SF6, HJE12SA6		—	121 [4.764]	
HJE12LF7~HJE12LF9, HJE12LA7~HJE12LA9		—	130 [5.118]	
HJE12SF7~HJE12SF9, HJE12SA7~HJE12SA9		—	130 [5.118]	

# HJE Series Dimensions of Manifold mm [in.]

Manifold with combined mounting of 2, 3, 5-port valves

## HJEM□F

(Direct piping type)

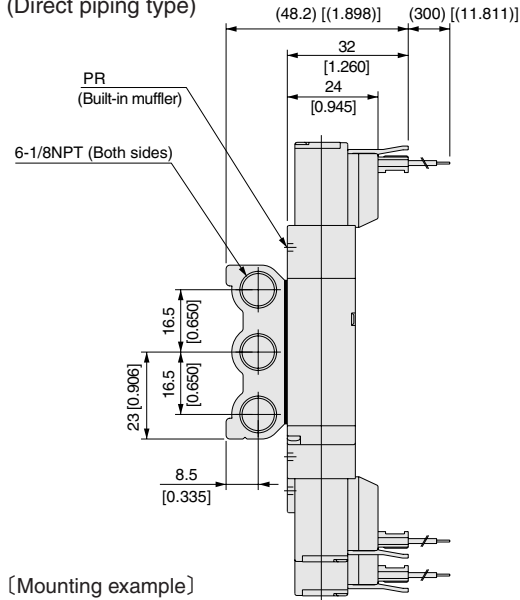

(Mounting example)

### HJEM6F

- stn.1 HJE12F3-PL-D4
- stn.2 HJE12F4-PL-D4
- stn.3 HJE12F5-PL-D4
- stn.4 HJE12F6-PL-D4
- stn.5 HJE12F7-PL-D4
- stn.6 HJEBP

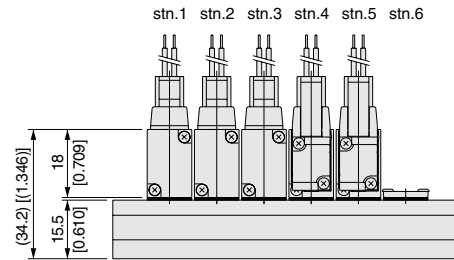
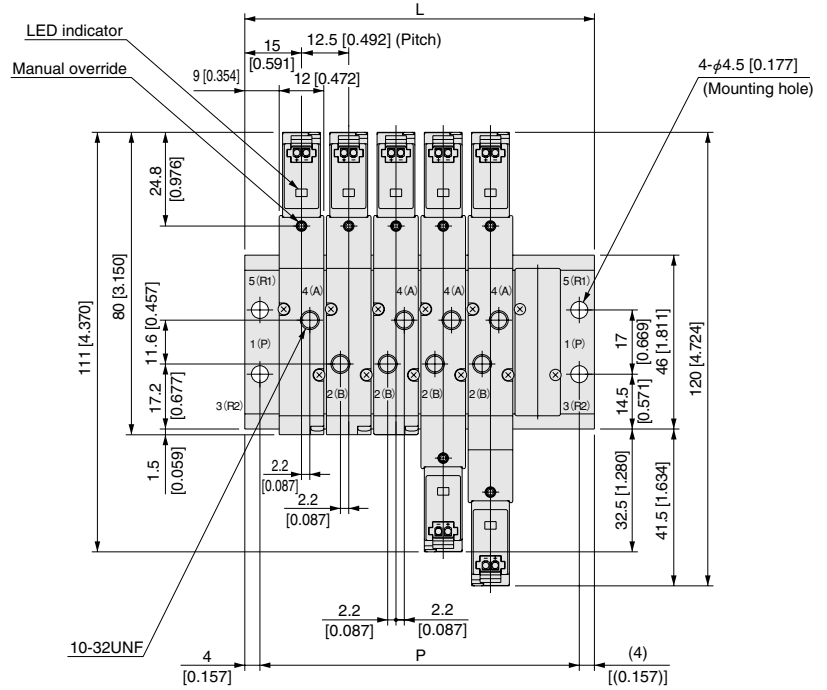

### Unit dimensions

Number of units	L	P
2	42.5 [1.673]	34.5 [1.358]
3	55.0 [2.165]	47.0 [1.850]
4	67.5 [2.657]	59.5 [2.343]
5	80.0 [3.150]	72.0 [2.835]
6	92.5 [3.642]	84.5 [3.327]
7	105.0 [4.134]	97.0 [3.819]
8	117.5 [4.626]	109.5 [4.311]
9	130.0 [5.118]	122.0 [4.803]
10	142.5 [5.610]	134.5 [5.295]
11	155.0 [6.102]	147.0 [5.787]
12	167.5 [6.594]	159.5 [6.280]
13	180.0 [7.087]	172.0 [6.772]
14	192.5 [7.579]	184.5 [7.264]
15	205.0 [8.071]	197.0 [7.756]
16	217.5 [8.563]	209.5 [8.248]
17	230.0 [9.055]	222.0 [8.740]
18	242.5 [9.547]	234.5 [9.232]
19	255.0 [10.039]	247.0 [9.724]
20	267.5 [10.531]	259.5 [10.217]

# HJE Series Dimensions of Manifold mm [in.]

Manifold with combined mounting of 2, 3, 5-port valves

## HJEM □ A

(Base piping type)

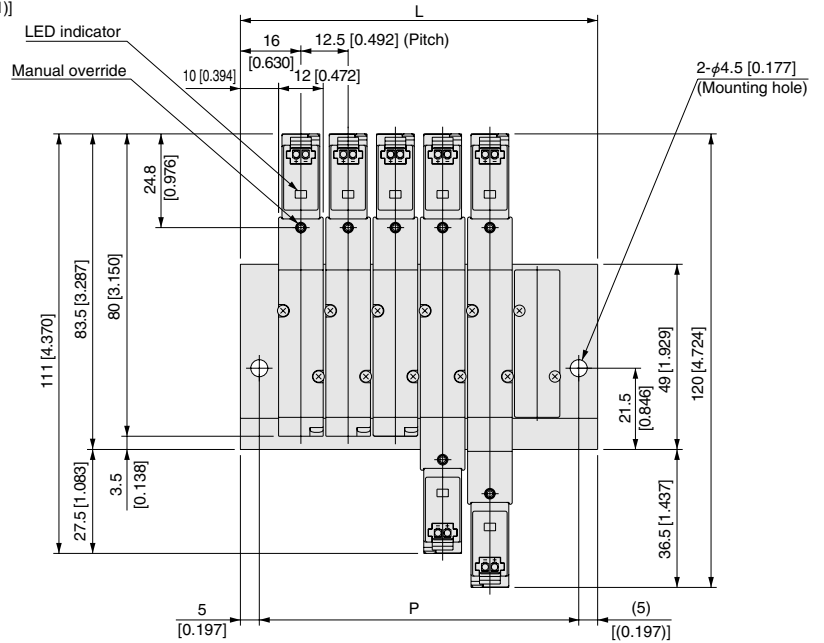
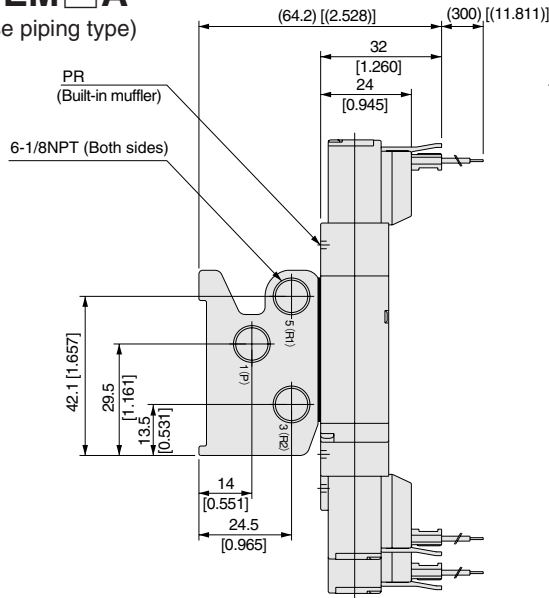

[Mounting example]

### HJEM6A

- stn.1 HJE12A3-PL-D4
- stn.2 HJE12A4-PL-D4
- stn.3 HJE12A5-PL-D4
- stn.4 HJE12A6-PL-D4
- stn.5 HJE12A7-PL-D4
- stn.6 HJEBP

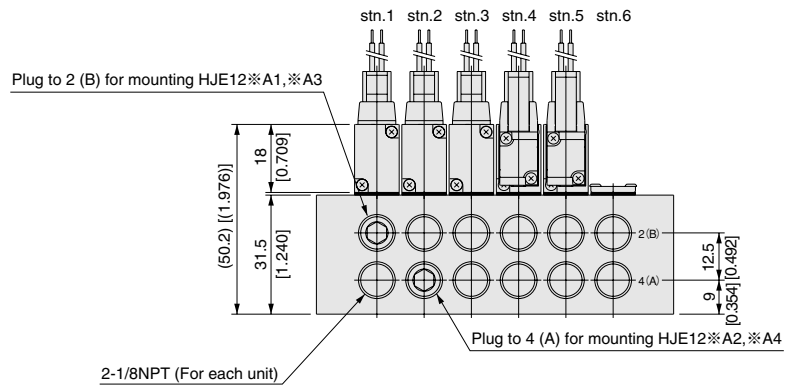

### ● DIN rail mounting bracket (-DN)

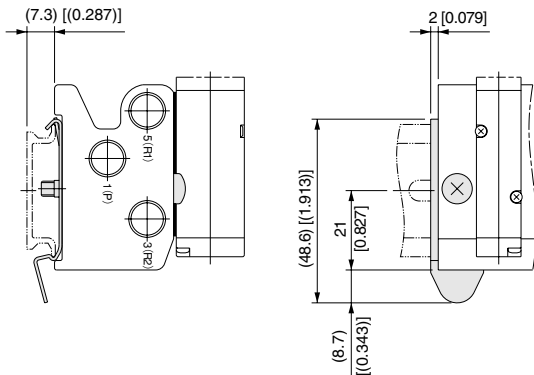

### Unit dimensions

Number of units	L	P
2	44.5 [1.752]	34.5 [1.358]
3	57.0 [2.244]	47.0 [1.850]
4	69.5 [2.736]	59.5 [2.343]
5	82.0 [3.228]	72.0 [2.835]
6	94.5 [3.720]	84.5 [3.327]
7	107.0 [4.213]	97.0 [3.819]
8	119.5 [4.705]	109.5 [4.311]
9	132.0 [5.197]	122.0 [4.803]
10	144.5 [5.689]	134.5 [5.295]
11	157.0 [6.181]	147.0 [5.787]
12	169.5 [6.673]	159.5 [6.280]
13	182.0 [7.165]	172.0 [6.772]
14	194.5 [7.657]	184.5 [7.264]
15	207.0 [8.150]	197.0 [7.756]
16	219.5 [8.642]	209.5 [8.248]
17	232.0 [9.134]	222.0 [8.740]
18	244.5 [9.626]	234.5 [9.232]
19	257.0 [10.118]	247.0 [9.724]
20	269.5 [10.610]	259.5 [10.217]